



# The Next Step in **Belting**



## DualDrive™ and Mini DualDrive™

Technical Manual

# Table of Contents

	Page
1. Introduction.....	3
2. Technical Data - DualDrive™.....	4
'H' Material DualDrive™ Belts.....	4
'DR' Material DualDrive™ Belts.....	6
'M' Material DualDrive™ Belts.....	8
'MD' Metal Detectable Material DualDrive™ Belts.....	10
'LT' Low Temperature Material DualDrive™ Belts.....	12
Recommended Flights Welding Location.....	14
Minimum Sprocket Specifications for DualDrive™ 'DR'/'M'/'LT'/'MD' Material Belts with Top Guides.....	14
Accessories.....	15
3. Technical Data - Mini DualDrive™.....	16
'M' Mini DualDrive™ Belts.....	18
Sprocket Guidelines & Fabrication Options.....	17
Recommended Flights Welding Location.....	17
Mini DualDrive™ Sprocket Specifications.....	18
4. Securing sprockets.....	19
Sprocket Bore Description.....	19
Locking Collars.....	19
5. Motorized pulley.....	21
6. Conveyor construction.....	21
Classic Conveyor Construction.....	21
Sprocket Spacing.....	22
How to Drive the Belt.....	23
Snub Rollers.....	23
Return Rails' Design.....	24
Containment of DualDrive™ Belting.....	24
Conveyor Retrofit.....	25
"Z" or Swan-neck Conveyor Construction.....	26
UHMW Strip Bed Construction.....	26
Center Drive Conveyor.....	27
Removing the Belt for Cleaning.....	27
7. Splicing DualDrive™ and Mini DualDrive™.....	28
FBW PD & Mini - Flat Butt Welding.....	28
FT - Electrode Welding Kit.....	28
Pitch Gauge Measuring Tool for Volta Positive Drive Belts.....	28
Volta Plastic Hinge Lace.....	29
Mechanical Laces.....	31
8. Belt Calculations.....	32
Pull Force Calculation Procedure.....	32
9. Motor Capacity Calculation.....	35

## 1. Introduction

DualDrive™(DD) and Mini DualDrive™(MDD) are fully extruded PD belts with lateral teeth across the belt base with a pitch of 2” and 1” respectively.

- | The DD and MDD models are designed to replace similar pitch modular belts with a minimum of retrofitting. (Changing the drive sprockets is usually advised).
- | Retrofitting DD and MDD in these cases improves hygiene and offers significant savings in cost of ownership, reducing factory running costs.

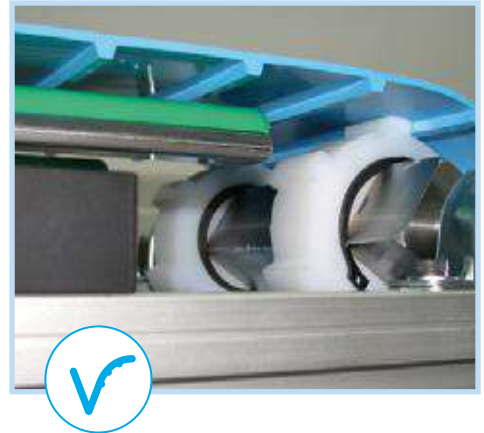

## Material Features

- | Smooth homogenous non-porous surfaces prevent bacteria build-up resulting in maximum product shelf-life.
- | No plies, edge fraying, modular components or hinges that can break apart and find their way into the final product as foreign bodies.
- | Non absorbent of water, oils or chemicals.
- | Does not harbor odors.
- | Wide operating temperature range.
- | USDA Equipment Acceptance.
- | In compliance with USDA Dairy Equipment Review Guidelines.
- | Declaration of Conformity in compliance with Food Contact Regulations: EU No.-10/2011, 1935/2004, 2023/2006 and relevant amendments.
- | Complies with the Requirements of Code of Federal Regulations (CFR21) USDA FDA article 21 CFR 177.2600..
- | Supports the HACCP concept.

DualDrive™ & Mini DualDrive™ positive drive belts lower water consumption, maintenance and sanitation costs while drastically boosting hygiene during production.

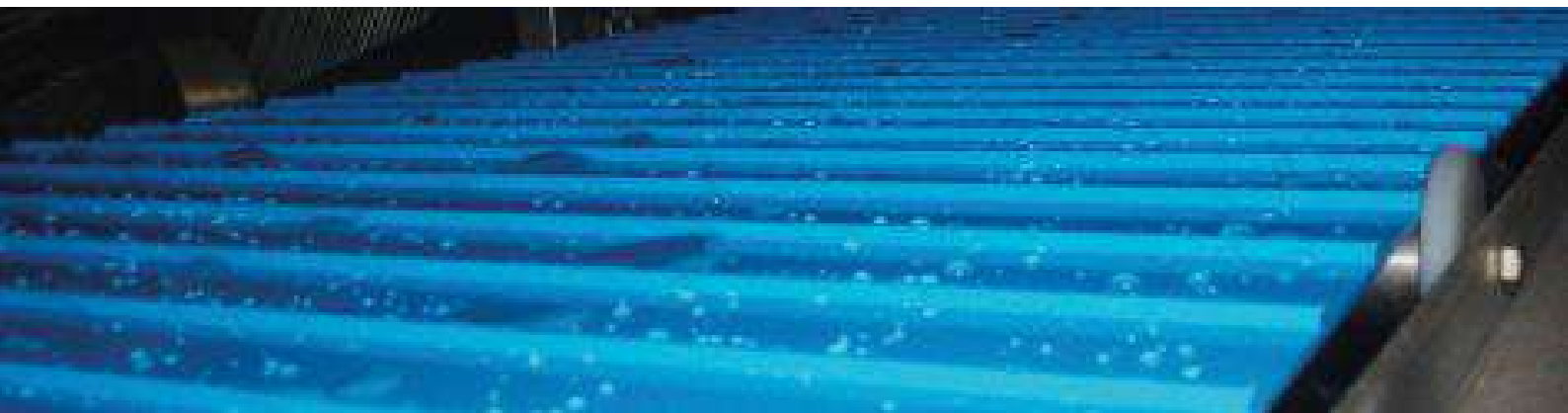

## Mechanical Benefits

- | Replaces modular systems that require extensive cleaning and lengthy soaking.
- | Greatly reduces noise levels when compared to modular belting.
- | Drive teeth prevent slippage of the belt.
- | Minimal pre-tension reduces strain on the belt and prevents elongation.
- | Teeth are an integral part of the belt, eliminating the chance of detachment.
- | Easy to install and provides a strong base for quality heat welded and HF welded fabrications.
- | Lightweight conveyor belt, reducing motor energy usage.

## 2. Technical Data - DualDrive™

### 'H' Material DualDrive™ Belts

The 'H' material DualDrive™ belts designed for higher temperatures and for harsh chemical conditions.

- | **Material:** Volta HB, Blue16
- | **Shore Hardness:** 55D
- | **Temperature Range** (see Table 8b)\*: -20°C to 90°C/-5°F to 194°F
- | **Coefficient of Friction:** Steel: 0.40/Stainless Steel: 0.40/UHMW: 0.20
- | **Certification:** FDA/USDA/USDA Dairy/ EU Approved

\* According to "Temperature Correction Factor" from Table 8b. Page 33.

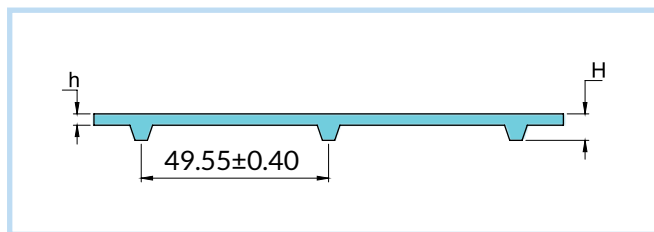

h= Belt Thickness, H=Belt Thickness + 4.30mm  
 Pitch Between Teeth: 49.55 ± 0.40mm  
 Standard Belt Width: 1524mm/60"

Table 2.a

Product		FHB-3-DD
Belt thickness (mm)		h=3, H=7.30
Belt weight (kg/m <sup>2</sup> )		4.50kg/m <sup>2</sup>
Belt weight (lb/ft <sup>2</sup> )		0.92lb/ft <sup>2</sup>
Minimum sprocket diameter Normal flex*	Temp ≥ 0°C/32°F	126mm/4.96"
	Temp < 0°C/32°F	150mm/5.90"
Minimum sprocket diameter Back flex*	Temp ≥ 0°C/32°F	189mm/7.44"
	Temp < 0°C/32°F	225mm/8.86"
Max. pull force (kg/cm width)		7
Max. pull force (lb/in width)		39.20

**Important Note:** 'H' Material DualDrive™ belts can only be driven with Volta sprockets.

\*All inch sizes have been converted from metric sizes.

## Sprocket Guidelines & Fabrication Options

Table 2.b

Belt Type	FHB-3-DD	
Temperature	Temp 0°C/32°F	Temp < 0°C/32°F
MPD Base Belt	126mm/4.96"	150mm/5.90"
<b>Minimum Sprocket Diameter for V-Flights</b>		
Electrode	158mm/6.22"	182mm/7.16"
VW/VWB 10	183mm/7.20"	207mm/8.15"
VW/VWB 13	203mm/7.99"	227mm/8.93"
VW/VWB 17	243mm/9.56"	267mm/10.51"
<b>Minimum Sprocket Diameter for Electrode Welded Flights</b>		
Single Electrode 7	183mm/7.20"	207mm/8.15"
Single Electrode 9	203mm/7.99"	227mm/8.93"
Double Electrode 7	218mm/8.58"	242mm/9.52"
Double Electrode 9	NR	

**Note:** NR - Not Recommended.

All inch sizes have been converted from metric sizes.

- | **Flights:** should be welded between the teeth as indicated in the sketch on page 14. Can be welded over the teeth if they do not exceed the tooth width. Must not be welded next to the teeth as indicated in the sketch.
- | **Sprockets:** must be equal to or larger than the minimum sprocket specification..

## 'DR' Material DualDrive™ Belts

'DR' belts have excellent hydrolysis resistant properties. Specially recommended for applications where the belts are exposed to a variety of chemicals.

- | **Material:** Volta DR, Blue15
- | **Shore Hardness:** 53D
- | **Temperature Range** (see Table 8b)\*: -20°C to 70°C/-5°F to 158°F
- | **Coefficient of Friction:** Steel: 0.55/Stainless Steel: 0.55/UHMW: 0.28
- | **Certification:** FDA/ EU/ USDA Approved

\*According to "Temperature Correction Factor" from Table 8b. Page 33.

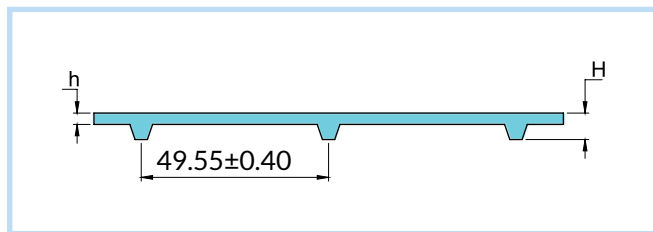
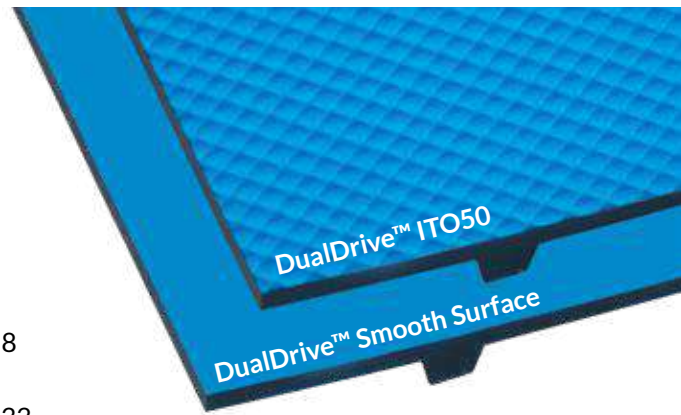

h= Belt Thickness, H=Belt Thickness + 4.30mm  
 Pitch Between Teeth: 49.55 ± 0.40mm  
 Standard Belt Width: 1524mm/60"

Table 2.c

Product	FDR-3-DD-V1 / FDR-3-DD-ITM2-V1	FDR-3-DD-ITO50-V1
Belt Thickness (mm)	h=3, H=7.30	h=3, H=7.30
Belt weight (kg/m <sup>2</sup> )	4.50 kg/m <sup>2</sup>	3.78 kg/m <sup>2</sup>
Belt weight (lb/ft <sup>2</sup> )	0.92 lb/ft <sup>2</sup>	0.77 lb/ft <sup>2</sup>
Minimum sprocket diameter Normal flex*	100 mm/4"	100 mm/4"
Minimum sprocket diameter Back flex*	100 mm/4"	100 mm/4"
Max. pull force (kg/cm width)	6.5	6.5
Max. pull force (lb/in width)	36.3	36.3

**Important Note:** 'DR' Material DualDrive™ belts can only be driven with Volta sprockets.

\*All inch sizes have been converted from metric sizes.

# Sprocket Guidelines & Fabrication Options

Table 2.d

Belt Type	FDR-3-DD-V1 / FDR-3-DD-ITM2-V1 / FDR-3-DD-ITO50			
MPD Base Belt	100 mm		4"	
<b>Minimum Sprocket Diameter for V-Flights*</b>				
Electrode EVDR	130 mm		5.31"	
VDR-10-V1	148 mm		5.82"	
VDR-13-V1	161 mm		6.34"	
VDR-17-V1	207 mm		8.15"	
<b>Minimum Sprocket Diameter for High Frequency Welded Flights</b>				
App. Temperature	Temp ≥ 0° C/32° F		Temp < 0° C/32° F	
Flight 3 - 5mm	106 mm	4.17"	165 mm	6.5"
Flight 6 - 8mm	136 mm	5.35"	195 mm	7.68"
<b>Minimum Sprocket Diameter for Baseless Sidewalls* (2mm thick)</b>				
	Normal Flex		Back Flex	
B-SW-30mm/1"	100 mm	3.94"	110 mm	4.33"
B-SW-40mm/1.50"	100 mm	3.94"	120 mm	4.72"
B-SW-50mm/2"	100 mm	3.94"	150 mm	5.90"
B-SW-60mm/2.50"	110 mm	4.33"	180 mm	7.10"
B-SW-80mm/3"	130 mm	5.12"	230 mm	9.05"
B-SW-100mm4"	160 mm	6.30"	300 mm	11.81"
B-SW-130mm/5"	210 mm	8.27"	400 mm	15.75"
B-SW-150mm/6"	250 mm	9.84"	450 mm	17.72"
<b>Minimum Sprocket Diameter for Two Top Guides* - (See also page 14)</b>				
Guide Type	Normal Flex		Back Flex	
VDR-10-V1	166 mm	6.53"	166 mm	6.53"
VDR-13-V1	180 mm	7.08"	180 mm	7.08"
VDR-17-V1	228 mm	8.98"	228 mm	8.98"

**Note:** \* Wait 2 hours before checking the welding quality of fabrications welded with hot air.

Leister Set-up : Welding speed +/- 0.5m/min; Power: 7.5-8.5.

All inch sizes have been converted from metric sizes.

- | **DR material should be used for HF welded flights:** Should be welded between the teeth as indicated in the sketch on page 17. Can be welded over the teeth if they do not exceed the tooth width, but not next to the teeth, as indicated in the sketch.
- | **Sprockets:** must be equal to, or larger than the minimum sprocket specification.

# 'M' Material DualDrive™ Belts

- Material: Volta MW, Beige / Volta MB, Blue / Volta MB, Blue02
- Shore Hardness: 53D
- Temperature Range (see Table 8b)\*: -20°C to 70°C / -5°F to 158°F
- Coefficient of Friction: Steel: 0.50 / Stainless Steel: 0.50 / UHMW: 0.28
- Certification: FDA / USDA / USDA Dairy / EU Approved

\*According to "Temperature Correction Factor" from Table 8b. Page 33.

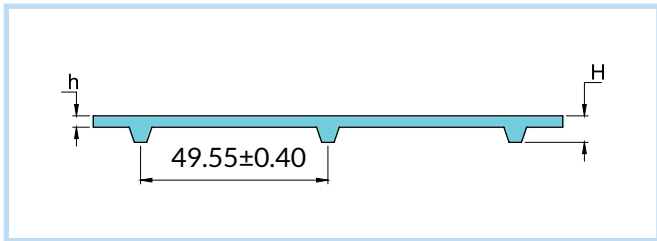
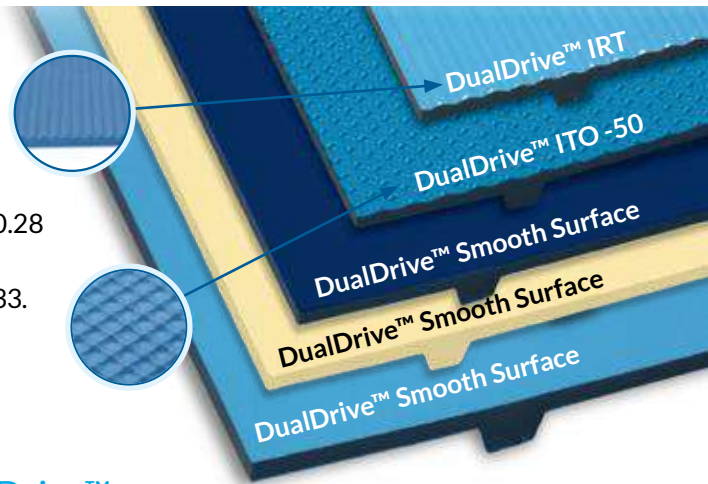

## DualDrive™

- \*h = Belt Thickness, H = Belt Thickness + 4.30mm
- Pitch Between Teeth: 49.55 ± 0.40mm
- Standard Belt Width with Shiny Surface: 1524mm/60"
- Standard Belt Width with Matt (ITM2) Surface: 2032mm/80"

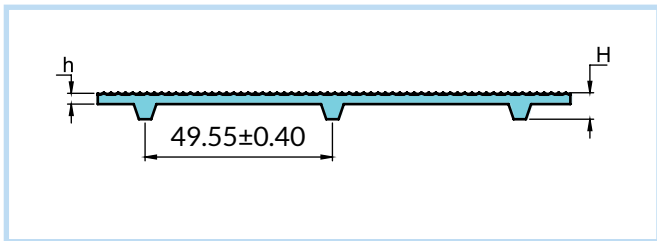

## DualDrive™ ITO-50

- \*h = Belt Thickness, H = Belt Thickness + 4.30mm
- Pitch Between Teeth: 49.55 ± 0.40mm
- Belt Width: 1524mm/60" and 2032mm/80"

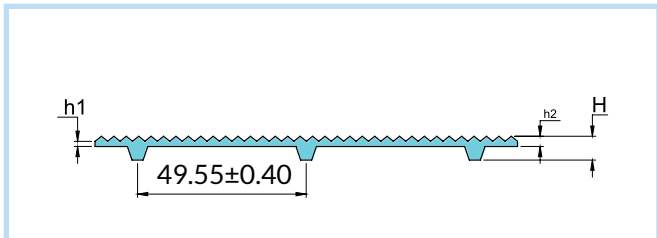

## DualDrive™ IRT

- \*h1 = Belt Thickness, h2 = Belt Thickness + 0.70mm
- H = Belt Thickness + 4.30mm
- Pitch Between Teeth: 49.55 ± 0.40mm
- Standard Belt Width: 1524mm/60"

Table 2.e

Product	FMB-3-DD/FMW-3-DD FMB-3-DD BLUE02 FMB-3-DD-ITM2/FMW-3-DD-ITM2	FMB-3 DD- ITO50	FMB-4- DD	FMB-4-DD-IRT
Belt Thickness (mm)	h=3, H=7.30	h=3, H=7.30	h=4, H=8.30	h1=3.30, h2=4, H=8.30
Belt weight (kg/m <sup>2</sup> )	4.50kg/m <sup>2</sup>	4.20kg/m <sup>2</sup>	5.70kg/m <sup>2</sup>	4.60kg/m <sup>2</sup>
Belt weight (lb/ft <sup>2</sup> )	0.92lb/ft <sup>2</sup>	0.86lb/ft <sup>2</sup>	1.16lb/ft <sup>2</sup>	0.94lb/ft <sup>2</sup>
Minimum sprocket diameter Normal flex*	80mm/3 <sup>1</sup> / <sub>4</sub> "		120mm/4 <sup>3</sup> / <sub>4</sub> "	100mm/4"
Minimum sprocket diameter Back flex*	100mm/4"		140mm/5 <sup>1</sup> / <sub>2</sub> "	120mm/4 <sup>3</sup> / <sub>4</sub> "
Max. pull force (kg/cm width)	6		7.70	6
Max. pull force (lb/in width)	33.60		43	33.60

**Note:** This belt can also be driven on existing modular belt sprocket sizes:  
 • 8 teeth, 5.2"/132mm • 10 teeth, 6.5"/165mm.

\*All inch sizes have been converted from metric sizes

# Sprocket Guidelines & Fabrication Options

Table 2.f

Belt Type	FMB-3-DD-ITM2 / FMW-3-DD-ITM2 FMB-3-DD / FMW-3-DD / FMB-3-DD BLUE02 FMB-3-DD-ITO50				FMB-4-DD			
	MPD Base Belt	80mm		3.15"		120mm		4.72"
<b>Minimum Sprocket Diameter for V-Flights</b>								
Electrode	120mm		4.72"		150mm		5.90"	
VLC/VLB-10	130mm		5.12"		170mm		6.70"	
VLC/VLB-13	140mm		5.51"		180mm		7.08"	
VLC/VLB-17	155mm		6.10"		195mm		7.68"	
<b>Minimum Sprocket Diameter for Electrode Welded Flights</b>								
Single Electrode 7	125mm		4.92"		150mm		5.90"	
Single Electrode 9	140mm		5.51"		165mm		6.50"	
Double Electrode 7	165mm		6.50"		190mm		7.48"	
Double Electrode 9	N.R.				N.R.			
<b>Minimum Sprocket Diameter for High Frequency Welded Flights</b>								
App. Temperature	Temp ≥ 0°C / 32°F		Temp < 0°C / 32°F		Temp ≥ 0°C / 32°F		Temp < 0°C / 32°F	
Flight 3 - 5mm	101mm	3.97"	151mm	5.94"	128mm	5.04"	180mm	7.09"
Flight 6 - 8mm	128mm	5.04"	180mm	7.09"	143mm	5.63"	200mm	7.87"
<b>Minimum Sprocket Diameter for Based Sidewalls - Normal Flex</b>								
SW-20	130mm		5.12"		145mm		5.70"	
SW-30	130mm		5.12"		145mm		5.70"	
SW-40	130mm		5.12"		145mm		5.70"	
SW-50	130mm		5.12"		145mm		5.70"	
SW-60	130mm		5.12"		145mm		5.70"	
SW-80	155mm		6.10"		155mm		6.10"	
SW-100	210mm		8.27"		210mm		8.27"	
<b>Minimum Sprocket Diameter for Baseless Sidewalls (2mm thick)</b>								
	Normal Flex		Back Flex		Normal Flex		Back Flex	
B-SW 30mm/1"	80mm	3.15"	110mm	4.33"	120mm	4.72"	140mm	5.51"
B-SW 40mm/1.5"	90mm	3.54"	120mm	4.72"	120mm	4.72"	140mm	5.51"
B-SW 50mm/2"	100mm	3.94"	150mm	5.90"	120mm	4.72"	160mm	6.30"
B-SW 60mm/2.5"	110mm	4.33"	180mm	7.10"	120mm	4.72"	190mm	7.50"
B-SW 80mm/3"	130mm	5.12"	230mm	9.05"	130mm	5.12"	240mm	9.45"
B-SW 100mm/4"	160mm	6.30"	300mm	11.81"	160mm	6.30"	310mm	12.20"
B-SW 130mm/5"	210mm	8.27"	400mm	15.75"	210mm	8.27"	420mm	16.53"
B-SW 150mm/6"	250mm	9.84"	450mm	17.72"	250mm	9.84"	470mm	18.50"
<b>Minimum Sprocket Diameter for Two Top Guides - (See also page 14)</b>								
Guide Type	Normal Flex		Back Flex		Normal Flex		Back Flex	
VLB/VLC-13	152mm	5.89"	157mm	6.18"	194mm	7.64"	199mm	7.83"
VLB/VLC-17	178mm	7"	175mm	6.89"	218mm	8.58"	215mm	8.46"
VLB/VLC-22	220mm	8.66"	240mm	9.45"	262mm	10.31"	288mm	11.34"
CLB/CLC-13	130mm	5.11"	147mm	5.79"	172mm	6.77"	189mm	7.44"
CLB/CLC-17	146mm	5.74"	160mm	6.30"	186mm	7.32"	200mm	7.87"
CLB/CLC-22	170mm	6.69"	190mm	7.48"	212mm	8.35"	234mm	9.21"
VSB/VSC-13	132mm	5.19"	141mm	5.55"	174mm	6.85"	183mm	7.20"
VSB/VSC-17	145mm	5.70"	150mm	5.90"	185mm	7.28"	190mm	7.48"
VSB/VSC-22	165mm	6.50"	190mm	7.48"	205mm	8.07"	237mm	9.33"
CSB/CSC-13	116mm	4.57"	134mm	5.27"	158mm	6.22"	176mm	6.93"
CSB/CSC-17	124mm	4.88"	140mm	5.51"	164mm	6.45"	180mm	7.09"

**Note:** NR-Not Recommended.

All inch sizes have been converted from metric sizes.

- | **Electrode Welded Flights:** We recommend welding the flights above the teeth location and flight thickness should not exceed the tooth base width.
- | **Flights:** should be welded between the teeth as indicated in the sketch on page 14. Can be welded over the teeth if they do not exceed the tooth width, but not next to the teeth as indicated in the sketch.
- | **Sprockets:** must be equal to, or larger than the minimum sprocket specification.

## 'MD' Metal Detectable Material DualDrive™ Belts

- | Material: Volta MB-MD, Blue09
- | Shore Hardness: 53D
- | Temperature Range: -20°C to 60°C/-5°F to 140°F
- | Coefficient of Friction: Steel: 0.5/Stainless Steel: 0.5/UHMW: 0.28
- | Certification: FDA/EU Approved

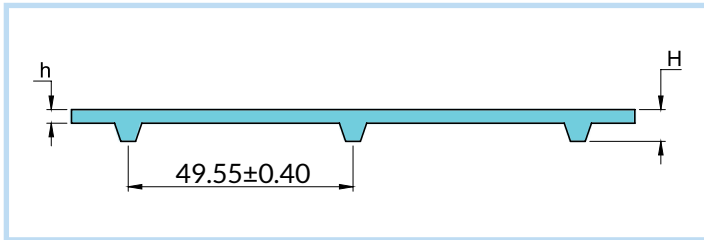

\*h = Belt Thickness, H = Belt Thickness + 4.30mm  
**Pitch Between Teeth: 49.55 ± 0.40**  
**Standard Belt Width: 1524mm/60"**

Table 2.g

Product	FMB-3-DD-MD
Belt Thickness (mm)	h=3, H=7.30
Belt weight (kg/m <sup>2</sup> )	4.80kg/m <sup>2</sup>
Belt weight (lb/ft <sup>2</sup> )	0.98lb/ft <sup>2</sup>
Minimum sprocket diameter Normal flex*	100mm/4"
Minimum sprocket diameter Back flex*	110mm/4.33"
Max. pull force (kg/cm width)	6
Max. pull force (lb/in width)	33.60

**Note:** \*All inch sizes have been converted from metric sizes.

# Sprocket Guidelines & Fabrication Options

Table 2.h

Belt Type	FMB-3-DD-MD			
MPD Base Belt	100mm		4"	
<b>Minimum Sprocket Diameter for V-Flights</b>				
Electrode EVMB-MD	135mm		5.31"	
VLB-MD-10	145mm		5.70"	
VLB-MD-13	155mm		6.10"	
VLB-MD-17	170mm		6.70"	
<b>Minimum Sprocket Diameter for Electrode Welded Flat Flights</b>				
Single Electrode 7	140mm		5.51"	
Single Electrode 9	150mm		6.10"	
Double Electrode 7	180mm		7.08"	
Double Electrode 9	N.R.			
<b>Minimum Sprocket Diameter for High Frequency Welded Flat Flights</b>				
App. Temperature	Temp ≥ 0°C/32° F		Temp < 0°C/32° F	
Flight 3 - 5mm	116mm	4.56"	165mm	6.50"
Flight 6 - 8mm	143mm	5.62"	195mm	7.67"
<b>Minimum Sprocket Diameter for Baseless Sidewalls (2mm thick)</b>				
	Normal Flex		Back Flex	
B-SW 30mm/ 1"	110mm	4.33"	120mm	4.72"
B-SW 40mm/ 1.5"	110mm	4.33"	120mm	4.72"
B-SW 50mm/ 2"	110mm	4.33"	150mm	5.90"
B-SW 60mm/ 2.5"	110mm	4.33"	180mm	7.10"
B-SW 80mm/ 3"	130mm	5.12"	230mm	9.05"
B-SW 100mm/ 4"	160mm	6.30"	300mm	11.81"
B-SW 130mm/ 5"	210mm	8.27"	400mm	15.75"
B-SW 150mm/ 6"	250mm	9.84"	450mm	17.72"
<b>Minimum Sprocket Diameter for Two Top Guides - (See also page 14)</b>				
Guide Type	Normal Flex		Back Flex	
VLB-MD-13	152mm	5.89"	157mm	6.18"
VLB-MD-17	178mm	7"	175mm	6.89"
VLB-MD-22	220mm	8.66"	240mm	9.45"

**Note:** NR - Not Recommended.

All inch sizes have been converted from metric sizes.

**⚠ Disclaimer:** Volta Belting Ltd. recommends testing all the products in your environment to ascertain suitability. The information is supplied in good faith without warranty.

## Guidelines and Suggested Materials for the Fabrication of FMB-3-DD-MD Belt

- | **Electrode Welded Flights:** We recommend welding the flights above the teeth location and flight thickness should not exceed the tooth base width.
- | **Flights:** should be welded between the teeth as indicated in the sketch on page 14. Can be welded over the teeth if they do not exceed the tooth width, but not next to the teeth as indicated in the sketch.
- | **Sprockets:** must be equal to, or larger than the minimum sprocket specification.

## 'LT' Low Temperature Material DualDrive™ Belts

- | **Material:** MB-LT, Blue15
- | **Shore Hardness:** 95A/46D
- | **Temperature Range** (see Table 8b)\*: -35°C to 65°C/-31°F to 149°
- | **Coefficient of Friction:** Steel: 0.55/Stainless Steel: 0.55/UHMW: 0.30
- | **Certification:** FDA/EU Approved

\* According to "Temperature Correction Factor" from Table 8b. Page 33.

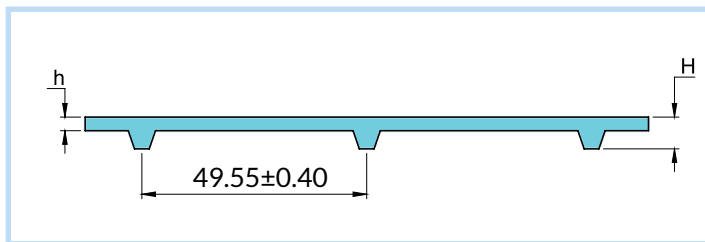
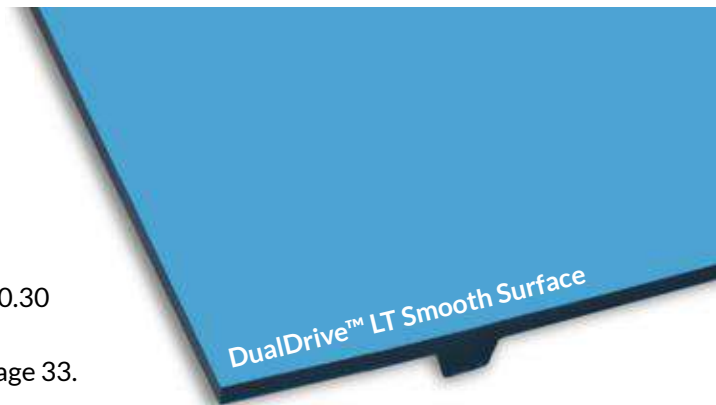

\*h = Belt Thickness, H = Belt Thickness + 4.30mm  
**Pitch Between Teeth:** 49.55 ± 0.40  
**Standard Belt Width:** 1524mm/60"

Table 2.i

Product	FMB-3-DD-LT
Belt Thickness (mm)	h=3, H=7.30
Belt weight (kg/m <sup>2</sup> )	4.50kg/m <sup>2</sup>
Belt weight (lb/ft <sup>2</sup> )	0.92lb/ft <sup>2</sup>
Minimum sprocket diameter Normal flex*	80mm/3 1/4"
Minimum sprocket diameter Back flex*	100mm/4"
Max. pull force (kg/cm width)	3
Max. pull force (lb/in width)	16.80

**Important Note:** "LT" Low Temperature DualDrive™ belts can only be driven with Volta sprockets  
 \*All inch sizes have been converted from metric sizes.

# Sprocket Guidelines & Fabrication Options

Table 2.j

Belt Type	FMB-3-DD-LT			
MPD Base Belt	80mm		3.15"	
<b>Minimum Sprocket Diameter for V-Flights</b>				
Electrode EVMB-LT	120mm		4.72"	
VLB/VLC/VLB-LT-10	130mm		5.12"	
VLB/VLC/VLB-LT-13	140mm		5.51"	
VLB/VLC/VLB-LT-17	155mm		6.10"	
<b>Minimum Sprocket Diameter for High Frequency Welded Flights</b>				
App. Temperature	Temp ≥ 0° C/32° F		Temp < 0° C/32° F	
Flight 3 - 5mm	101mm	3.97"	151mm	5.94"
Flight 6 - 8mm	128mm	5.04"	180mm	7.09"
<b>Minimum Sprocket Diameter for Baseless Sidewalls (2mm thick)</b>				
	Normal Flex		Back Flex	
B-SW-30mm/1"	80mm	3.15"	110mm	4.33"
B-SW-40mm/1.50"	90mm	3.54"	120mm	4.72"
B-SW-50mm/2"	100mm	3.94"	150mm	5.90"
B-SW-60mm/2.50"	110mm	4.33"	180mm	7.10"
B-SW-80mm/3"	130mm	5.12"	230mm	9.05"
B-SW-100mm4"	160mm	6.30"	300mm	11.81"
B-SW-130mm/5"	210mm	8.27"	400mm	15.75"
B-SW-150mm/6"	250mm	9.84"	450mm	17.72"
<b>Minimum Sprocket Diameter for Two Top Guides - (See also page 14)</b>				
Guide Type	Normal Flex		Back Flex	
VLB-LT/ VLB/VLC-13	152mm	5.89"	157mm	6.18"
VLB-LT/VLB/VLC-17	178mm	7"	175mm	6.89"
VLB/VLC-22	220mm	8.66"	240mm	9.45"
CLB/CLC-13	130mm	5.11"	147mm	5.79"
CLB/CLC-17	146mm	5.74"	160mm	6.30"
CLB/CLC-22	170mm	6.69"	190mm	7.48"
VSF/VSC-13	132mm	5.19"	141mm	5.55"
VSF/VSC-17	145mm	5.70"	150mm	5.90"
VSF/VSC-22	165mm	6.50"	190mm	7.48"
CSB/CSC-13	116mm	4.57"	134mm	5.27"
CSB/CSC-17	124mm	4.88"	140mm	5.51"

All inch sizes have been converted from metric sizes.

## Guidelines and Suggested Materials for the Fabrication of FMB-3-DD-LT Belt

- | **HF Welded Flights:** LT material should be used for the flights. MB material is also acceptable but in this case you should make sure that the temperature of your application, including disinfection procedures, do not exceed the regular MB-LT materials limit. Should be welded between the teeth as indicated in the sketch on page 14. Can be welded over the teeth if they do not exceed the tooth width, but not next to the teeth as indicated in the sketch
- | **Sidewalls:** It is possible to weld sidewalls from L material to the LT belts.
- | **Endless Joining:** We recommend joining LT belts with a butt weld using FBW Tool.
- | **Sprockets:** Must be equal to, or larger than the minimum sprocket specification.

## Recommended Welding Location for Flights

Locations 1 & 4 are not recommended because the flight is in line with the tooth engagement area.  
Locations 2 & 3 are recommended.

- | **HF welding:** Location 3 is recommended.  
Location 2 is optional.
- | **Electrode welding:** Location 2 is recommended.  
Location 3 is optional.

**Note:** In location 2, it is essential that the cleat and weld widths do not exceed the width of the belt tooth.

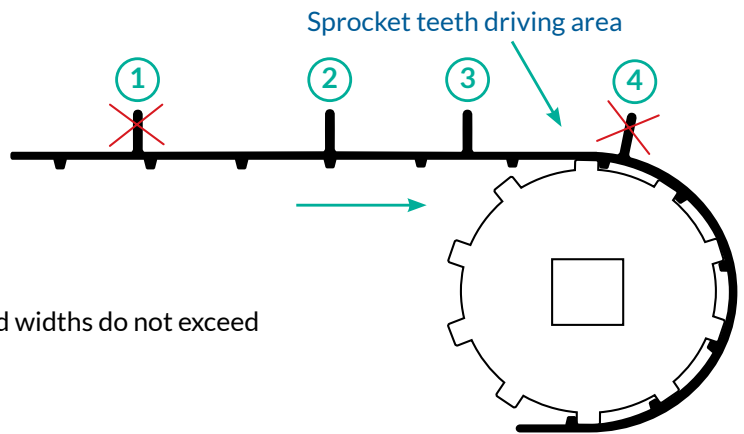

## Minimum Sprocket Specifications for DualDrive™ 'DR'/'M'/'LT'/'MD' Material Belts with Top Guides

For DualDrive™ belts with a width of 600mm guides should be welded on both upper edge sides of the belt, indented to allow grooved roller to run over them. The belt guides sit in v-grooved rollers in the transition sections of the conveyor.

- | When using wide belts, it is very important to support the belt on the return side. Using cleats may cause excess sagging, and it may be necessary to make a center gap in the cleat to enable supporting the belt.

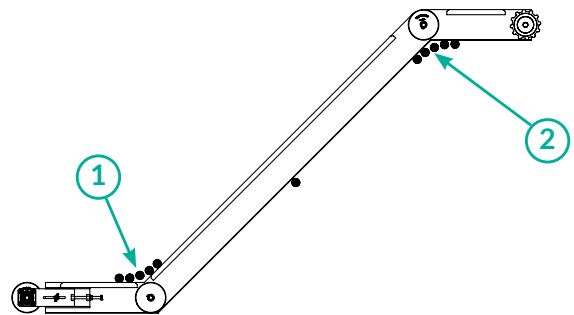

Back flex location can be seen in positions ① and ②

Belt Type	DualDrive™ 3mm Thick Belts				DualDrive™ 4mm Thick Belts			
	Normal Flex		Back Flex		Normal Flex		Back Flex	
VLB/VLC; VLB-LT; VLB-MD-13	152mm	5.89"	157mm	6.18"	194mm	7.64"	199mm	7.83"
VLB/VLC; VLB-LT; VLB-MD-17	178mm	7"	175mm	6.89"	218mm	8.58"	215mm	8.46"
VLB/VLC; VLB-LT; VLB-MD-22	220mm	8.66"	240mm	9.45"	262mm	10.31"	288mm	11.34"
CLB/CLC-13	130mm	5.11"	147mm	5.79"	172mm	6.77"	189mm	7.44"
CLB/CLC-17	146mm	5.74"	160mm	6.30"	186mm	7.32"	200mm	7.87"
CLB/CLC-22	170mm	6.69"	190mm	7.48"	212mm	8.35"	234mm	9.21"
VSB/VSC-13	132mm	5.19"	141mm	5.55"	174mm	6.85"	183mm	7.20"
VSB/VSC-17	145mm	5.70"	150mm	5.90"	185mm	7.28"	190mm	7.48"
VSB/VSC-22	165mm	6.50"	190mm	7.48"	205mm	8.07"	237mm	9.33"
CSB/CSC-13	116mm	4.57"	134mm	5.27"	158mm	6.22"	176mm	6.93"
CSB/CSC-17	124mm	4.88"	140mm	5.51"	164mm	6.45"	180mm	7.09"
VDR-10-V1	166mm	6.53"	166mm	6.53"				
VDR-13-V1	180mm	7.08"	180mm	7.08"				
VDR-17-V1	228mm	8.98"	228mm	8.98"				

All inch sizes have been converted from metric sizes.

## Accessories

Volta Belting provides all the accessories required to operate the DualDrive™ belt.

### Sprockets

Volta Sprockets are manufactured from abrasion resistant materials that ensure a long and reliable operating life. All the sprockets - both white and blue color- are made from FDA approved material.

#### Volta Provides two types of Sprockets:

Machined Drive Sprockets made of UHMW material in white and blue\*:

- | Ensures durability in high friction applications and long life
- | Easy to clean

Blue Acetal Molded Drive Sprockets and Tail Rollers:

- | Available in 6T, 8T and 10T dimensions
- | Suits both to 40mm and 1.50" square bore shaft
- | Easy to clean

\* Machined UHMW Sprockets in blue color are not standard - please check availability.

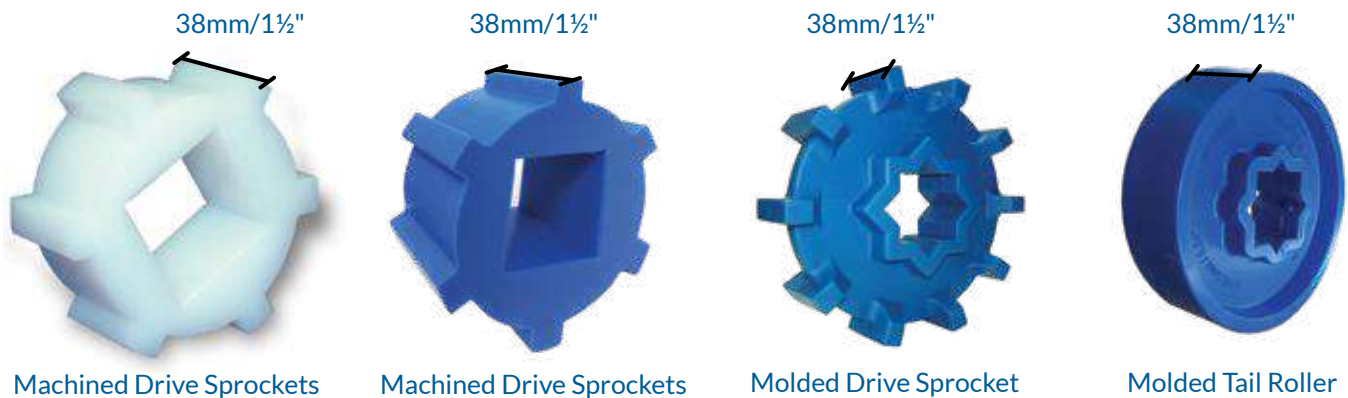

## DualDrive™ Sprockets

Number of Teeth	Sprocket Outer Diameter		Belt Pitch Diameter			
	3mm & 4mm Thick Belts		3mm Thick Belts		4mm Thick Belts	
	mm	inch	mm	inch	mm	inch
6	93.40	3.67	96.40	3.79	97.40	3.83
8*	125.60	4.94	128.60	5.06	129.60	5.10
10*	157.70	6.20	160.70	6.32	161.70	6.36
12	189.90	7.47	192.90	7.59	193.90	7.63

- | Standard Sprocket Width=38mm/1½"
- | Standard Square Bore Dimensions=40mm/1½"
- | Non-Standard Round Bores are available upon request.
- | Non-Standard Sprocket Diameters are available upon request.
- | \*Molded Sprockets constructed with "Star" bore: 40mm and 1½" combined together. Sprocket width 38mm/1½".
- | Non-Standard Square Bore Dimensions, available upon request: • 25mm/1"; • 50mm/2"; • 2½".



### 3. Technical Data - Mini DualDrive™

#### 'M' Mini DualDrive™ Belts

- | **Material:** Volta MB, Blue
- | **Shore Hardness:** 95A/46D
- | **Temperature Range** (see Table 8b)\*: -20°C to 70°C/-5°F to 158°F
- | **Coefficient of Friction:** Steel: 0.50/Stainless Steel: 0.50/UHMW: 0.28
- | **Certification:** FDA/USDA/USDA Dairy/EU Approved

\* According to "Temperature Correction Factor" from Table 8b. Page 33.

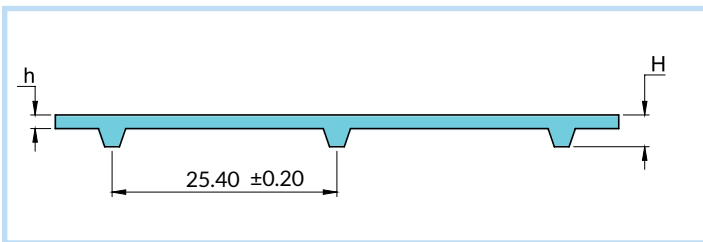
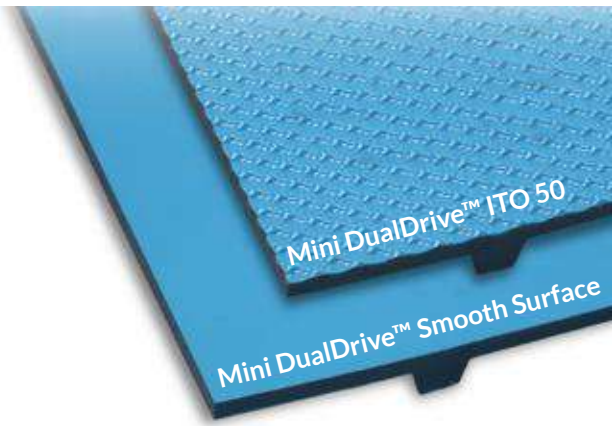

\***h** = Belt Thickness, **H** = Belt Thickness + 3.50mm  
**Pitch Between Teeth:** 25.40mm/1"  
**Standard Belt Width:** 2032mm/80"

Product	FMB-2.5-MDD	FMB-2.5-MDD-ITO50
Belt Thickness (mm)	h=2.50, H=6	h=2.50, H=6
Belt weight (kg/m <sup>2</sup> )	3.70kg/m <sup>2</sup>	3.17kg/m <sup>2</sup>
Belt weight (lb/ft <sup>2</sup> )	0.76lb/ft <sup>2</sup>	0.65lb/ft <sup>2</sup>
Minimum sprocket diameter Normal flex	48mm/1.89"	48mm/1.89"
Minimum sprocket diameter Back flex	65mm/2.56"	65mm/2.56"
Max. pull force (kg/cm width)	4	4
Max. pull force (lb/in width)	22.40	22.40

\* All inch sizes have been converted from metric sizes.

## Sprocket Guidelines & Fabrication Options

Belt Type	FMB-2.5-MDD/FMB-2.5-MDD-ITO50	
MPD Base Belt	48mm/1.89"	
<b>Minimum Sprocket for Flat High Frequency Welded Cleats</b>		
App. Temperature	T ≥ 0°C/32°F	T < 0°C/32°F
Cleats 3-4mm	80mm/3.15"	120mm/4.70"

**Note:** Contact Volta Belting representative for further details regarding Mini DualDrive™ belt. All inch sizes have been converted from metric sizes.

- | **Flights:** Flights positioning: Flights must be welded between the teeth centers as indicated in the sketch below.  
Maximum cleat thickness: 4mm.  
Maximum cleat height: 60mm.
- | **Sidewalls:** Contact Volta Belting representative.

### Recommended Flights Welding Location

- | **HF welding:** Location 3 is recommended.
- | **Electrode welding:** Is NOT permitted.

Locations 1 & 4 are not permitted.

**Note:** In location 2, it is essential that the cleat and weld widths do not exceed the width of the belt tooth.

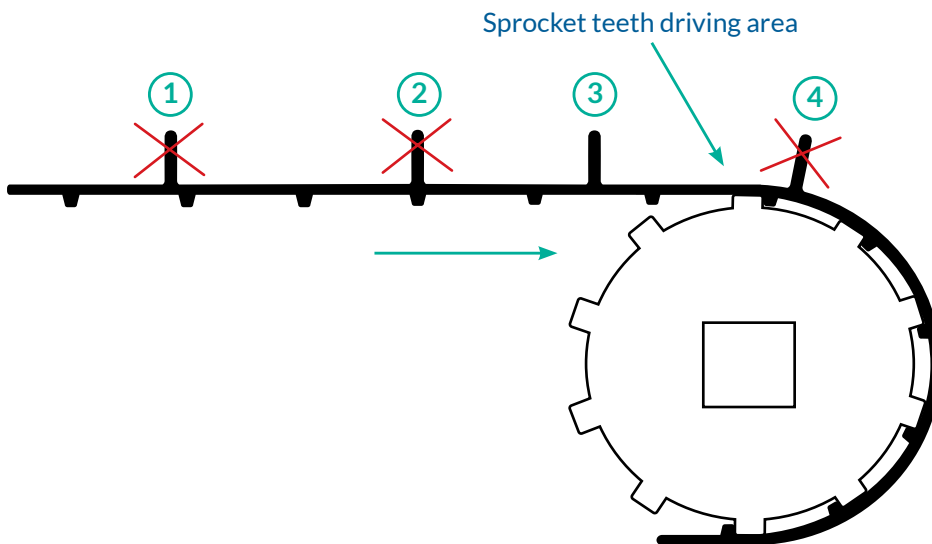

## Mini DualDrive™ Sprocket Specifications

Number of Teeth	6		8		10		12		19	
	mm	inch	mm	inch	mm	inch	mm	inch	mm	inch
Measurement	mm	inch	mm	inch	mm	inch	mm	inch	mm	inch
Sprocket Outer Diameter	48	1.89	65	2.56	80	3.15	96.50	3.80	154.30	6.07
Belt Pitch Diameter	50.50	1.98	67.5	2.65	82.50	3.24	99	3.89	156.80	6.17
Special Smooth Tail Sprockets	-	-	-	-	-	-	88.70	3.49	-	-
Standard Bore Size (Square)*	20	3/4	25	1	40	1.50	40	1.5	40	1.5
Special Round Bore Diameter**	25	1	25	1	-	-	-	-	-	-
Max. Possible Square Bore Diameter	20	3/4	25	1	40	1.50	50	2	-	-
Max. Possible Round Bore Diameter	25	1	38	1.50	50	2	65	2.50	-	-
Sprocket Width	25	1	25	1	25	1	25	1	25	1
Sprocket Locking Device	Retainer Ring						Volta Locking Collar or Retainer Ring			

**Note:** \* Non-Standard Square Bores (See Pg.20) are available upon request: 3/4"-20mm; 1"-25mm; 2"-50mm; 2.5"- 65mm.  
 \*\* Round Bore Sprockets (with keyway) are made from Acetal.

- | Standard Sprocket Width=25mm/1"
- | Standard Square Bore Dimensions=40mm/1½"
- | Tail Rollers / may be used when sprocket diameter is larger than 76.2mm/3"
- | Sprockets for center drive conveyors =19 Teeth =154.30mm/6.07" available upon request.



MDD Sprocket



## 4. Securing Sprockets

### Sprocket Bore Description

The DualDrive™ sprockets are available in two standard square bore dimensions 1.50" & 40mm.

Sprocket bore dimensions should be chosen according to the load on the shaft to avoid shaft deflection and to transmit the required torque.

Volta supplies other bore dimensions according to your requirements (25mm, 50mm, 1", 2", 2.50"). Please contact Volta for availability.

### Locking Collars

**Square Stainless Steel Locking Collar** is made of two parts of stainless steel wire with two bolts. This system can be assembled without dismantling the shaft and can be used with all sprocket types on 1½" (40mm) square shafts.

**Square Plastic Locking Collar (UHMW)** is made of two plastic parts that lock with two bolts. The collar can be assembled without dismantling the shaft. It can be used with sprockets that have 12 or more teeth and are available in 1½"/40mm, 2" and 2.50" DualDrive™ sprockets.

Locking Collar face width=20mm.

Some collars can be ordered with round corner bores.

**Round Plastic Locking Collar (UHMW)** is suitable for DualDrive™ 8 teeth and Mini DualDrive™ 12 teeth sprockets and larger. The shaft can be dismantled in order to assemble this locking collar. The collar can be ordered in 1½"/40mm.

Locking Collar face width=20mm.

Some collars can be ordered with round corner bores.

**"C" Ring** - Use a "C" ring on both sides of the sprocket. Machine a groove suitable for the thickness of the "C" ring you are using. This method of securing the pulleys is standard with modular belting.

### Additional Options for Securing DualDrive™ Sprockets

Volta offers two alternative methods of securing sprockets to a shaft. We recommend checking with your engineering department regarding the effects this will have on the conveyor shafts. Volta does not supply materials for this procedure and is not responsible for damage to/or weakening of the shaft when using one of these options.

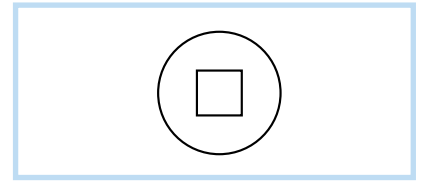

UHMW Sprocket with Square Bore

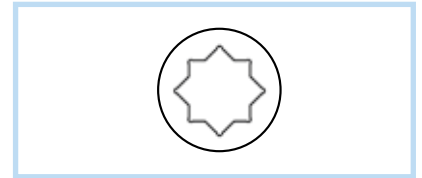

Molded Sprocket Bore Pattern Star Bore



Square Stainless Steel Locking Collar



Square Plastic (UHMW) Locking Collar



Round Plastic (UHMW) Locking Collar

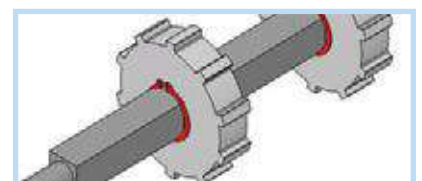

"C" Ring

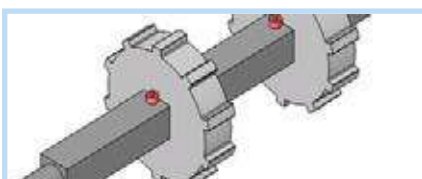



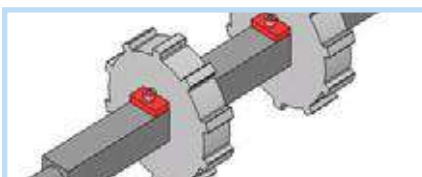



1. Drill and thread a hole at either end of the sprocket. Mount an Allen screw in each hole to secure the sprocket.







2. Mount a small piece of flat metal on either end of the sprocket. Drill and thread a hole in the shaft and mount an Allen screw to secure the metal plates.



## Locking Collars

Sprocket Outside Diameter	DualDrive™ Sprocket Description	Plastic Round Collar	Plastic Square Collar	Plastic Square Collar	Stainless Steel Collar	Stainless Steel Collar	"C" Ring
							
		Bore size 1.50"/40mm Face Width - 20mm/0.78"	Bore size 1.50"/40mm Face Width - 20mm/0.78"	Bore size 2"/50mm Face Width - 20mm/0.78"	Bore size 1.50"/40mm	Bore size 2"/50mm	Circlip
3.81"/93.50 mm	DD Sprocket 6T - 40mm				✓		471-56
	DD Sprocket 6T - 1.50"				✓		471-55
	DD Sprocket 6T Round Bore - 25mm						471-25
4.94"/125.60 mm	DD Sprocket 8T - 40mm	✓			✓		471-56
	DD Sprocket 8T - 1.50"	✓			✓		471-55
	DD Sprocket 8T Round Bore - 25mm						471-25
6.21"/157.70 mm	DD Sprocket 10T Round Bore - 1"						471-36
	DD Sprocket 10T - 40mm	✓	✓		✓		471-56
	DD Sprocket 10T - 1.50"	✓	✓		✓		471-55
	DD Sprocket 10T - 2.0"			✓		✓	
	DD Sprocket 10T Round Bore - 25mm						471-25
7.48"/190 mm	DD Sprocket 12T - 40mm	✓	✓		✓		471-56
	DD Sprocket 12T - 50mm			✓		✓	
	DD Sprocket 12T - 1.50"	✓	✓		✓		471-55
	DD Sprocket 12T - 2.0"			✓		✓	
	DD Sprocket 12T - 2.50"						

Sprocket Outside Diameter	Mini DualDrive™ Sprocket Description	Plastic Round Collar	Plastic Square Collar	Stainless Steel Collar	"C" Ring
					
		Bore size 1.50"/40mm Face Width - 20mm/0.78"	Bore size 1.50"/40mm Face Width - 20mm/0.78"	Bore size 1.50"/40mm	Circlip
1.89"/48mm	MDD Sprocket 6T Round Bore 1"				471-36
	MDD Sprocket 6T Round Bore 25mm				471-25
	MDD Sprocket 6T Square Bore 3/4"				471-26
	MDD Sprocket 6T Square Bore 20mm				471-27
2.56"/65mm	MDD Sprocket 8T Round Bore 1"				471-36
	MDD Sprocket 8T Round Bore 25mm				471-25
	MDD Sprocket 8T Square Bore 1"				471-36
	MDD Sprocket 8T Square Bore 25mm				471-25
3.15"/80mm	MDD Sprocket 10T Round Bore 1"				471-36
	MDD Sprocket 10T Round Bore 25mm				471-25
	MDD Sprocket 10T Square Bore 1.50"				471-55
	MDD Sprocket 10T Square Bore 40mm				471-56
3.80"/96.5mm	MDD Sprocket 12T Square Bore 1.50"	✓		✓	471-55
	MDD Sprocket 12T Square Bore 40mm	✓		✓	471-56
6.08"/154.3mm	MDD Sprocket 19T Square Bore 1.50"	✓	✓	✓	471-55
	MDD Sprocket 19T Square Bore 40mm	✓	✓	✓	471-56

**Note:** Some collars made of plastic (UHMW) material can be ordered with round corner bores.

## 5. Motorized Pulley

A motorized pulley (drum motor) is an assembly with a motor, gearbox and shaft sealed inside a metal shell. The motor transmits power through the gearbox, which is coupled to a geared rim fixed to the drum end housing.

The sealed casing makes the assembly impervious as well as resistant to liquids in process as well as to high pressure cleaning.

An added benefit when using a motorized pulley in conjunction with DualDrive™ is that this forms a completely hygienic conveying system that is easily cleaned.

Volta cooperates with the major motorized pulley manufacturers to develop toothed outer rings on the drums that correspond to the Volta Positive Drive pulleys including those for DualDrive™ and Mini DualDrive™.

Drum motors with a sprocket ring fabricated from UHMW will allow the same correct operation with all Volta Positive Drive belts as per the given belt specifications loads, temperatures, humidity and speed.

Please contact your local Volta Belting representative for more information.

## 6. Conveyor Construction

### Classic Conveyor Construction

The classic conveyor construction consists of the following parts:

- Volta Drive Sprockets mounted on the Drive end
- Smooth rollers (or discs) mounted on the Tail end
- Slide Bed made of UHMW (PE-1000) strips - to minimize friction at all contact points
- Take-up Device (Tensioner)
- Return Rollers
- Snub Rollers
- Best hygienic practice is to cantilever the idler axle in order to enable easy access to or removal of, an endless belt for cleaning.



If a stainless steel bed is required, note the high friction between the two surfaces may affect the adhering capacity and tracking of the belt. Please contact your Volta representative for construction recommendations and pull force calculation.

- ⚠ Prior to installation on a conveyor, the belt path should be thoroughly examined, on the slide bed, around the sprockets and on the belt return, to ensure that all these areas are free from catch points that can snag the belt. This includes any side wall or other extraneous areas where the belt might come into contact during normal use due to minimal sideways movement. All the contact areas (slide bed, sprockets and return supports) must be chamfered and/or rounded to avoid any sharp edges from grooving or scratching the belt surface (top and bottom) when loaded and moving. This examination should be repeated periodically as part of the regular maintenance procedure.

## Suggested Conveyor Slide Bed Construction with UHMW (PE-1000) Strips

When mounting the DualDrive™ or Mini DualDrive™ Sprockets make sure all sprockets' teeth are aligned with each other and properly positioned along the shaft.

**Note:** It is important to support the DualDrive™ and Mini DualDrive™ belts properly. Many conveyors originally built to run modular belts have fewer supports where a modular belt is laterally rigid. Sufficient support of DualDrive™ and Mini DualDrive™ is essential in order to avoid distortion and wear.

- B.** Distance between Slide Bed Support Strips: 75-150mm (3"-6"). Add strips depending on product size and weight, and for higher loads.
  - C.** The distance of the front edge of the slide strip from the sprocket depends on the cross section of the slide strip and the slide strip supports. Dimension 'C' should be kept to a minimum but still leaving dimension 'X' with a minimum of 20mm.
  - D.** Distance between Drive sprocket Centre and Slide Bed Support Strips:  
DualDrive™: Half of the drive sprocket diameter minus 4.30mm (1/8").  
Mini DualDrive™: Half of the drive sprocket diameter minus 3.50mm.
  - E.** Distance between Slide Bed Upper Surface and Return Bed Surface with 180° a belt wrap over the sprocket:  
DualDrive™: Drive sprocket diameter plus belt thickness minus 4.30mm (1/8").  
Mini DualDrive™: Drive sprocket diameter plus belt thickness minus 3.50mm (1/8").
  - F.** Strip width: 25-50mm (1"-2").
  - G.** Maximum distance between the belt edges and strip: 50mm (2").
  - H.** Allow gap "H" between rails for thermal expansion; Note rail ends chamfered. Strip section ends are staggered to reduce belt catch point of driving teeth while passing over the strips joint area.
- Ensure belt does not come in contact with any sharp edges, including all UHMW components and wear strips.
  - Chamfer strips in-feed and out-feed ends.
  - Bevel wear strips at ends.

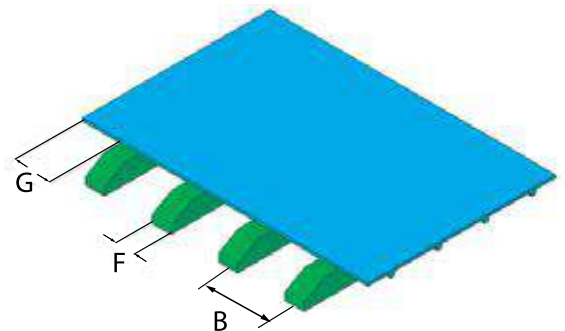
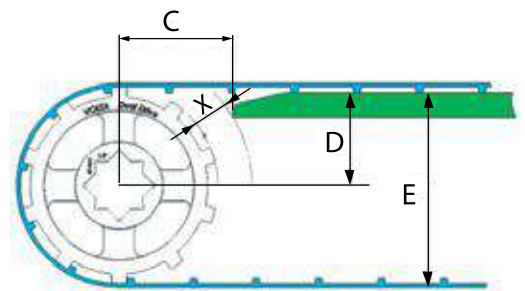
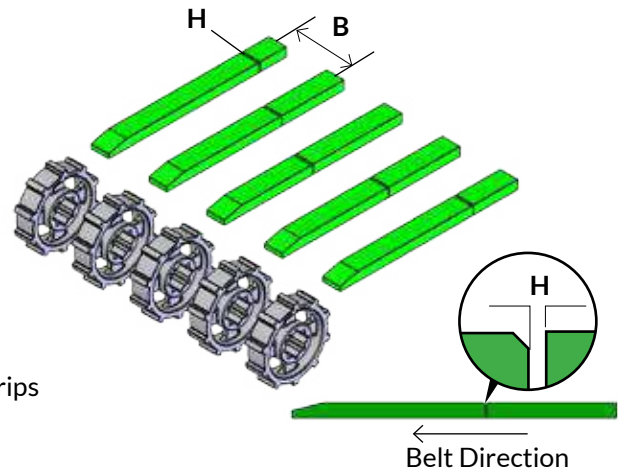

## Sprocket Spacing

- | Distance between DualDrive™ sprocket centers should be between 75mm to 150mm (3" to 6") according to the belt pull force.
- | In case of DualDrive™ if the applied pull force will be higher than 35% of the maximum allowed pull force, then the distance between the sprockets should be not more than 100mm (4"). For pull force higher than 50%, consider to reduce the distance to 75mm (3").
- | Distance between Mini-DualDrive™ sprocket centers should be between 75mm to 100mm (3" to 4") according to the belt pull force.
- | In case of Mini-DualDrive™ if the applied pull force will be higher than 35% of the maximum allowed pull force, then the distance between the sprockets should be not more than 75mm/3".
- | Minimum number of sprockets: 2.
- | Confirm there is no depression of the belt between sprockets. If depression occurs, add sprockets reducing the distance between the sprocket centers.
- | Sprocket location should be in line with the conveyor slide bed strips.



## How to Drive the Belt

A Belt is driven by first ensuring that the belt drive teeth are engaged with the drive sprocket. This is achieved by one or more of the following methods:

- Minimal pre-tensioning (up to 0.50% maximum);
- Controlling the catenary sag by means of a suitable return way design and / or with a snub roller.

The design should prevent belt slack occurring in the area where the belt wraps around the drive sprocket in order to ensure that the belt teeth do not disengage during operation (See Drawing 2). One must ensure a consistent arc of contact.

Pre-tensioning, Drawing 1, suits most of the applications and conveyor designs as long as the loads are not on the high end of the belt specifications. The use of return idlers design to control catenary sag as shown in Drawing 3, and the use of a snub roller adjacent to the sprocket, as an alternative or additional measure, is commonplace in conveyor design. One or more of these features is essential in applications where the belt length is expected to vary due to one of the following situations: a high product load; a wide temperature range; a relatively long conveyor.

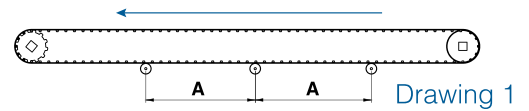

Drawing 1

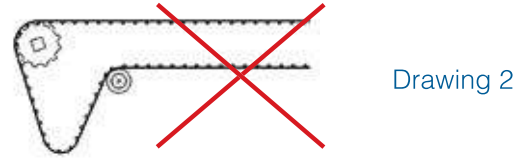

Drawing 2

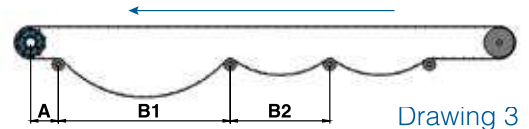

Drawing 3

## Take-up Device and Quick Release



The Take-up Device performs a number of functions on the conveyor. It enables the use of minimal, measured pre-tensioning; it facilitates the mounting and disassembly of the belt and it enables the use of extra belt length to simplify belt splicing.

The length of belt take-up allowed by a belt quick release take up device and its construction depend on the conveyor length, the cleaning method and the overall conveyor structure. Volta recommends using a minimum take-up of at least 5-8 inches (125-200mm) in any case. A quick release mechanism added to the take-up device means that a belt is returned to the same level of tensioning when released and repositioned for cleaning or conveyor maintenance. This mechanism allows

the belt to be lifted to provide easy and effective access to the underside of the belt as well as the guides and sprockets, for cleaning. After cleaning has been completed, the quick release take-up device can be re-engaged in order to return the belt to its correct pre-tension and alignment without additional adjustments.

## Return-Ways

Return roller design is shown in Drawing 3: Volta recommends 1m (3ft.) spacing between the rollers and depending on the application a maximum distance of 1.5 meters (5ft).

Note that if a belt is pre-tensioned (up to 0.5% maximum), the belt can sag due to its own weight. Take great care not to over-tension the belt. For longer conveyors with multiple catenary sags, we recommend to vary the support roller spacings: adjacent spacing gaps not to be identical length, to reduce oscillation of the belt on the return way. Once the belt runs under load, additional sagging is expected. Ensure that there is no sagging directly under the drive sprocket causing disengagement and also ensure that the sag does not contact with any part of the conveyor or other structures such as collecting pans or the floor.

Channeling the catenary sag by correct spacing of return rollers:

Return rollers should be placed to allow for belt accumulation to occur in a specific location or locations. The belt will tend to sag in the larger spacings on the return (B1; B2). On a decline conveyor, the sag can be expected to accumulate at the lower end. Smaller spacing seen at position "A", relatively to B1/B2, will help avoid sagging under the drive sprocket.

## Snub Rollers

Snub Rollers are widely used to increase the arc of contact on the drive sprocket, eliminating slack which can cause the drive teeth to disengage ("jumping"). Safety precautions must be taken to prevent access to the area where the snub roller is located.

## Return Rail Design

Return rails are a possible design option although rollers (idlers) are preferred. A belt will rub on return rails and this increased friction is a potential cause of wear on the belt work surface. Plan an area for the belt to sag and accumulate any extra length due to one or more of the following; high loads, a wide temperature range; relatively long conveyors. To permit a section of belt to sag, the return rails should not support the belt on the entire return way from drive to end idler shaft.

It is important to plan a large radius at the end of the rails where the belt is allowed to sag as shown in Drawing 4. Shoes (non-rotating elements) can be used in place of return rollers but must be made from UHMW as they are a cause of increased friction.

When using continuous rails, the lateral center distance between each rail should not exceed 12"/305mm and the outer edges should not be indented by more than 2"/50mm. In order to minimize the friction UHMW material is highly recommended.

For belts with flights consider to split the flight for belts 24"/610mm and wider. Keep a gap of at least 1/4"/6mm between the rails and the flights.

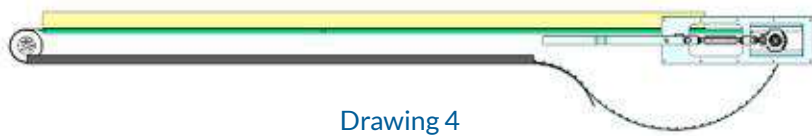

Drawing 4

## Containment of DualDrive™ Belting

The tracking of a DualDrive™ belt differs from standard flat belts that require tensioning or steering and from modular belts where the sprockets track the belt.

As DualDrive™ belts run without or with low pre-tensioning it is possible to contain the belt rather than track or guide it. The 2 steps required to achieve containment are:

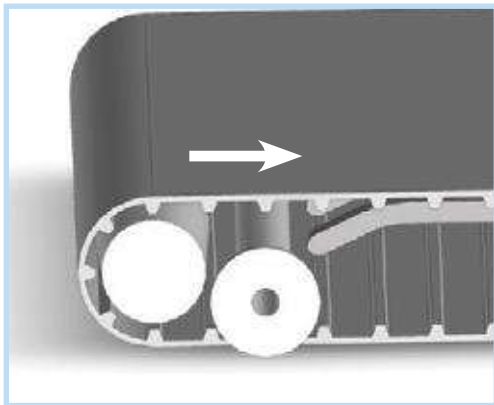

1. Flanged rollers on the return way.

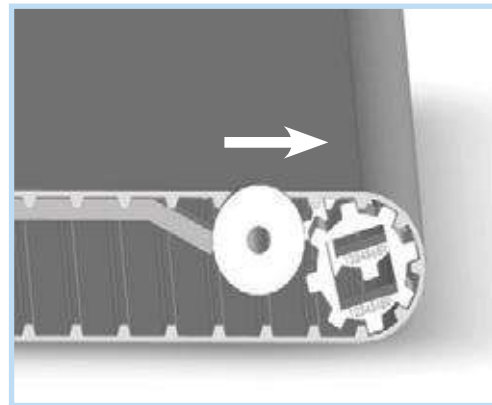

2. Flanged rollers before the drive side

| The roller and flanges should be wider than the belt and have clearance of at least 0.15–0.20"/4–5mm each side of the belt.

Another option is to use containment blocks (side shoes) which are used on the frame of the conveyor. In order to minimize friction it is essential to use UHMW in these contact points.

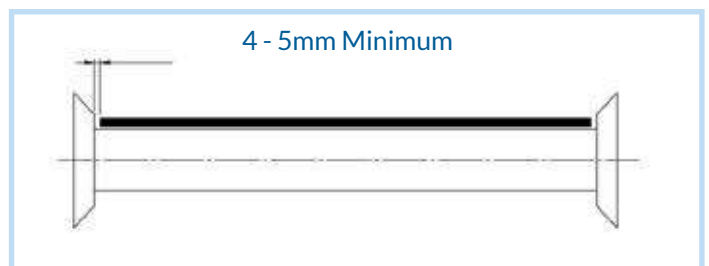

# Conveyor Retrofit

## Retrofit of Conveyor with a Flat Slide Bed

### 1. Flat Slide Bed

The belt can work on an existing flat steel slide bed but due to high friction, this should be avoided with heavy dry loads. A pull force calculation will indicate suitability. H material is more suited to this design. This construction is not recommended with 'DR', 'M', 'MD' & 'LT' material belts.

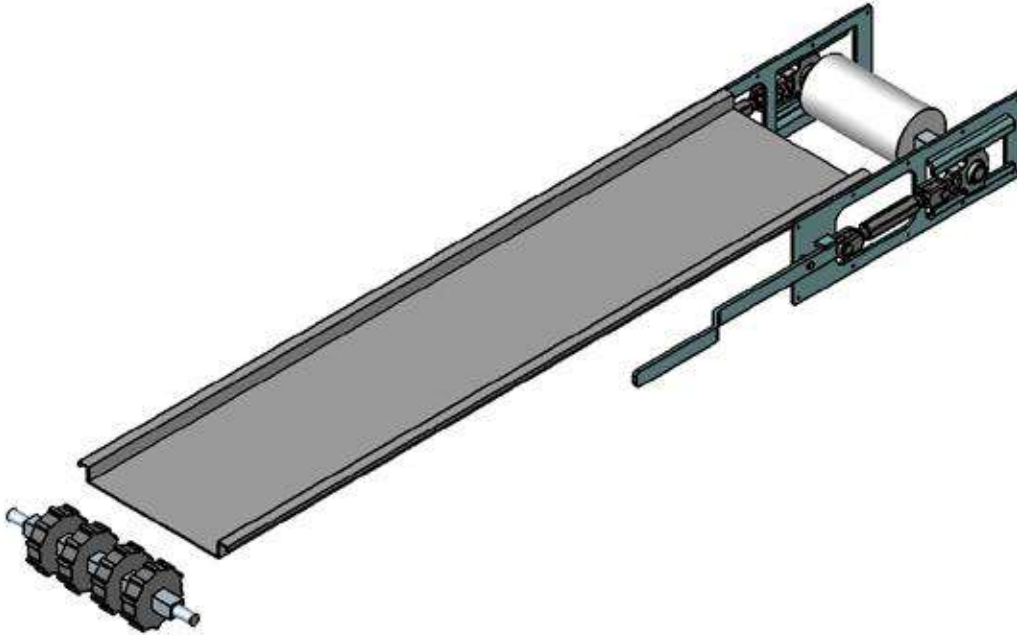

### 2. Slide Bed with UHMW (PE-1000) Strips

Slide Bed as seen in accompanying drawing is the recommended type, especially for 'DR', 'M', 'MD' & 'LT' material belt applications. The UHMW (PE-1000) strips reduce the coefficient of friction between the belt and the Slide Bed. This increases the carrying capacity of the belt. When replacing a thick modular belt, it may be necessary to raise the axles holding the drive sprockets and tail pulleys to allow the belt to engage properly onto the drive sprockets.

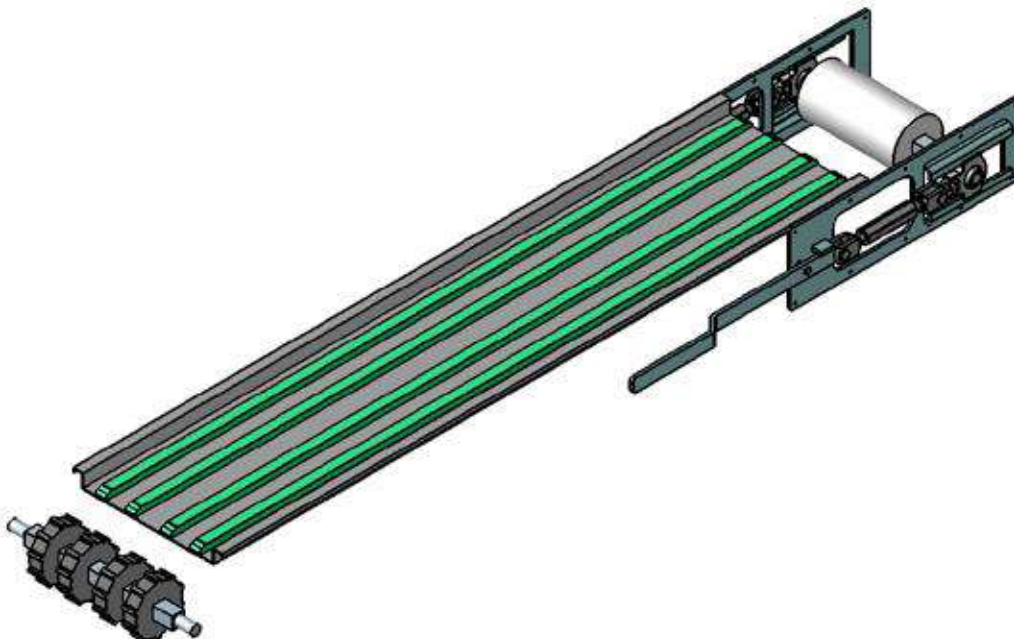

## "Z" or Swan-neck Conveyor Construction

The "Z" or Swan-neck conveyor is in common use for lifting products.

DualDrive™ (DD) and Mini DualDrive™ (MDD) are suited to this design for several reasons:

- The DualDrive™ and the MDD material are relatively stiff across the entire belt width and will not bend in the middle at the transition from a horizontal to an angled position.
- The DualDrive™ and the MDD operate without or with minimum pre-tensioning, therefore reduces problems of holding the belt in place.
- The transition areas (horizontal to elevation and back) can be assisted as for traditional belts, by using a single large roller or a set of small rollers (see drawing below).

## UHMW Strip Bed Construction

Figure 1

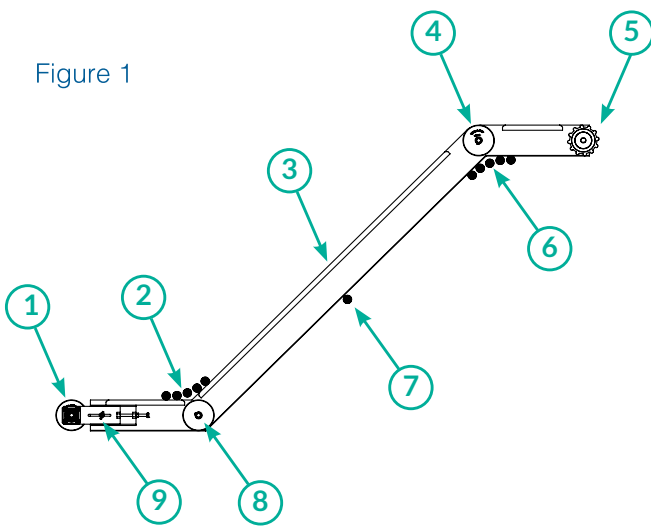

Demonstrates a typical Z - elevator conveyor construction showing a Slide Bed made from UHMW (PE 1000) Strips. In transition areas (2 & 4) - the belt will tend to rub against the conveyor's curved construction, thereby creating an area of high tension strain and friction. Therefore, it is recommended to use rollers at these two transition points to minimize the strain and friction.

1. Tail Sprockets
2. Roller Set: Transition Horizontal to Incline
3. Incline UHMW (PE-1000) Slide Bed
4. Top Roller: Transition Incline to Horizontal
5. Drive Sprockets
6. Roller Set: Return transition horizontal to decline
7. Return Support Roller
8. Bottom Roller: Return transition decline to horizontal
9. Take-up Device (Tensioner) for tail sprocket

## There are 3 typical options for the transition areas

Shoe - please consult with a Volta representative.

Roller - one large roller.

Roller sets consisting of 4-5 rollers.

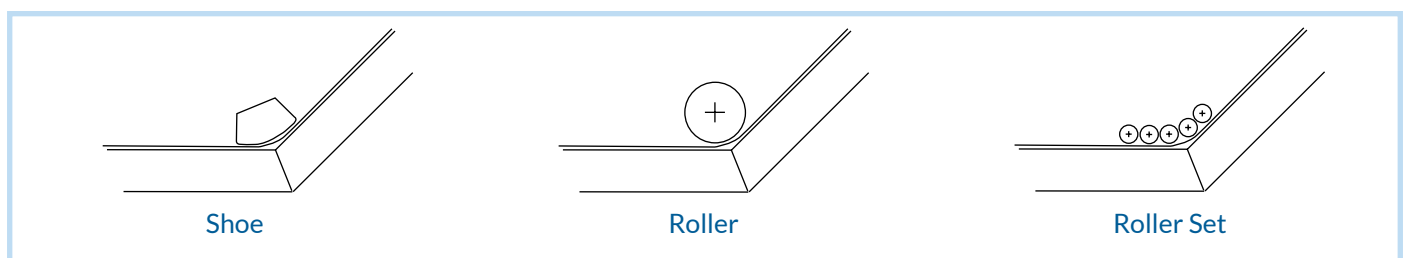

Swan-neck conveyor - transition rollers/ shoe (direction change) options

- The belt curve should be the maximum possible size and not less than the minimum sprocket back flex value of the specific belt with its fabrications. The bigger the curve, the less wear and tear. It is easier to fabricate a roller set than a shoe for large curves.
- Roller systems for transitions are best to insure the most optimal performance but a shoe system can be considered. If opting for a shoe system, please consult with a Volta representative to discuss details of the application
- For DualDrive™ belts with a width of 600mm or wider and Mini DualDrive™ belts with a width of 450mm or wider, we recommend using guides on both upper edge sides of the belt. The belt guides pass through the v-grooved rollers in the transition section to hold the belt.
- The V-groove of the rollers should be machined large enough so as not to contact BOTH the base belt and the V guide.
- When using wide belts, it is very important to support the belt on the return side. Using flights may cause excess sagging and it may be necessary to make a center gap in the flight to enable supporting the belt.

## Center Drive Conveyor

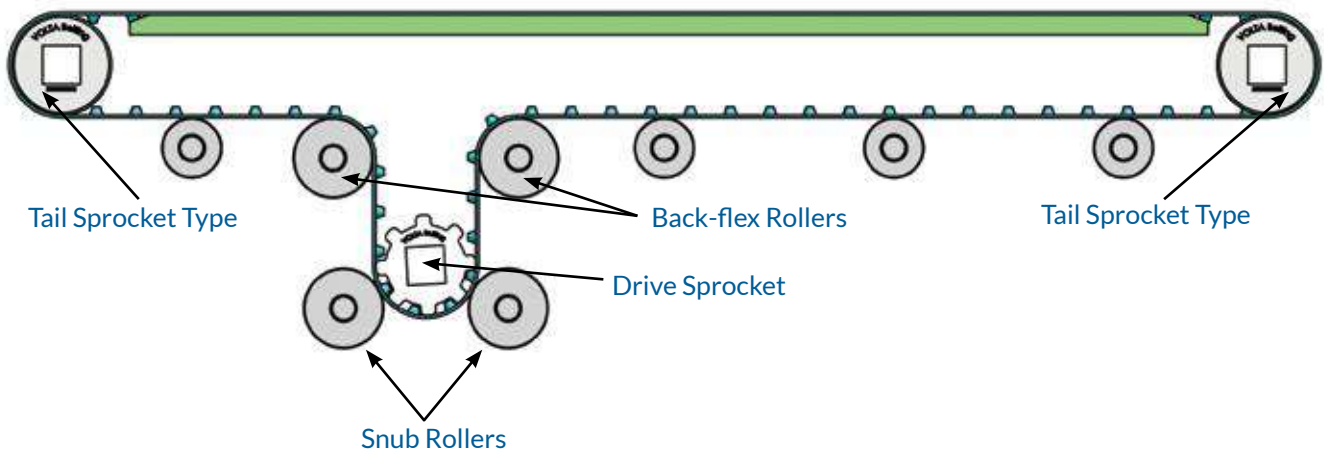

### This conveyor is used in two typical applications:

- One option is when the drive sprocket is large, the tail sprockets can be much smaller within the limitations of the minimum sprocket diameter of the base belt making the conveyor most suitable for tight transition of products. Only the drive shaft should be fitted with sprocket and all other shafts should have smooth rollers.
- Another option is when the conveyor works in two directions. In this case add two snub rollers as shown to ensure smooth operation. In most cases, snub rollers are placed both before and after the drive sprocket, positioned tightly against the drive sprocket on both sides. This ensures smooth operation when the belt is running in both directions.

## Removing the Belt for Cleaning

There are a number of options in the conveyor construction that allow the belt to be removed from the conveyor without being opened.

### These common features are:

- Take-up Device (Tensioner) - This device permits the release of belt tension.
- Hinge Lace, RoundFlex™ Lace or a mechanical fastener can be used to open the belt for cleaning and maintenance

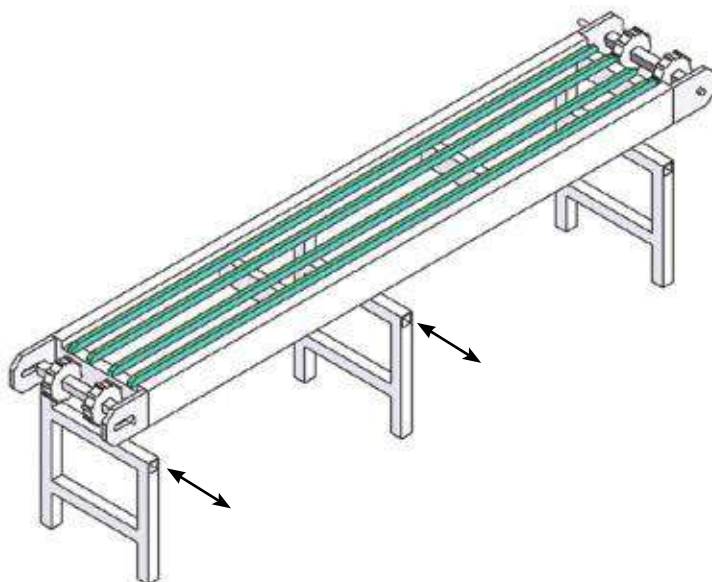

Conveyor Construction for quick dismantling of the belt

## 7. Splicing the DualDrive™ and the Mini DualDrive™

The DualDrive™ and the Mini DualDrive™ conveyor belt is manufactured with a series of teeth as an integral part of the belt. These teeth are designed to mesh with the teeth on the DualDrive™ and the Mini DualDrive™ drive sprockets. To ensure efficient performance, it is necessary to maintain the spacing between the teeth in the region of the weld. We recommend using Volta Tools for this procedure. These tools are designed for use with all of our belts and materials. They are also designed to maintain the correct spacing between the teeth on the DualDrive™ and the Mini DualDrive™ belt.

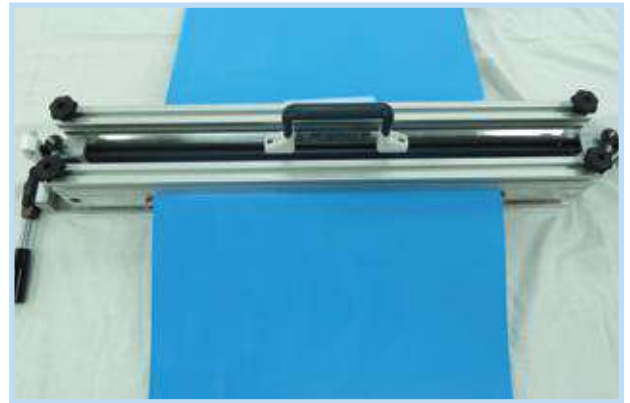

### FBW PD & Mini - Flat Butt Welding

The FBW PD & Mini System was created to butt-weld the belts endlessly. The FBW Welding System can be used for flat belts, SuperDrive™, DualDrive™, 1" Pitch belts (Mini SuperDrive™ & Mini DualDrive™). Adapters are available for welding special textured top flat belts. The FBW tool range offers maximum splicing width up to 2300mm (90.5").



### FT - Electrode Welding Kit FBW PD & Mini - Flat Butt Welding

For the FT Welding System extruded electrodes are used to endless splice Volta flat belts and SuperDrive™, DualDrive™, 1" Pitch belts (Mini SuperDrive™ & Mini DualDrive™). The FT Welding System uses a router to bevel the belt edges and to trim the excess weld on completion. The weld done with a Leister Hot Air Gun and Volta electrodes. When welding 2mm thick belts, use the 7mm section electrode and for thicker belts use, the 9mm section electrode. This tool is supplied with a built-in adaptor for welding DualDrive™ belts. The FT tool range offers maximum splicing width of 1000mm (39.4") and 1500mm (60").



### Pitch Gauge Measuring Tool for Volta Positive Drive Belts

Volta Positive Drive belts need to be welded endlessly while maintaining a correct pitch tolerance between the teeth closest to the weld. A tool gauge has been developed to ensure this. The Pitch gauge Measuring Tool is not included in the FBW Welding kit. This tool can be purchased as a separate unit - Cat. No. - 81307570.

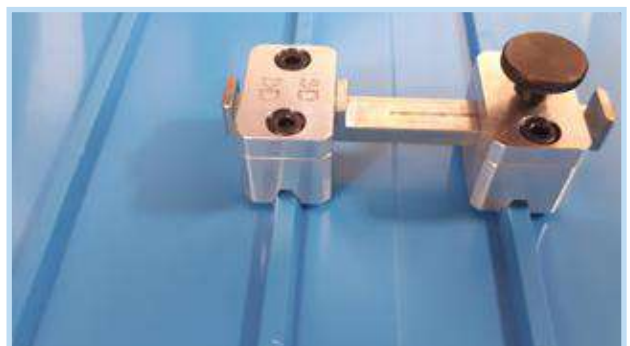

# Volta Hinge Lace Systems

The Plastic Hinge Lace allows to easily open the belt by removing the hinge pin. The belt should be closed after each refitting with a new pin. The Plastic Hinge Lace is made of Volta homogeneous food approved materials and is compatible with Volta M family belts from 2.5mm to 5mm thickness. Volta belts are renowned for their homogeneous and hygienic characteristics and, therefore, they do not require opening and joining on a regular basis- unlike modular belts. Welding instructions for the Volta Laces are included in our FBW (Flat Butt Welding) tool instruction manual.

## Hinge Lace Benefits

### Easy Open-Close Technique

The fastening structure allows you to easily open both the Universal Lace and the Roundflex™ Lace by removing the hinge pin from the lace. After setting up the belt on the conveyor, fasten the lace and secure it by inserting a new hinge pin into the slit and crimp up the pin ends.

### Universal Lace

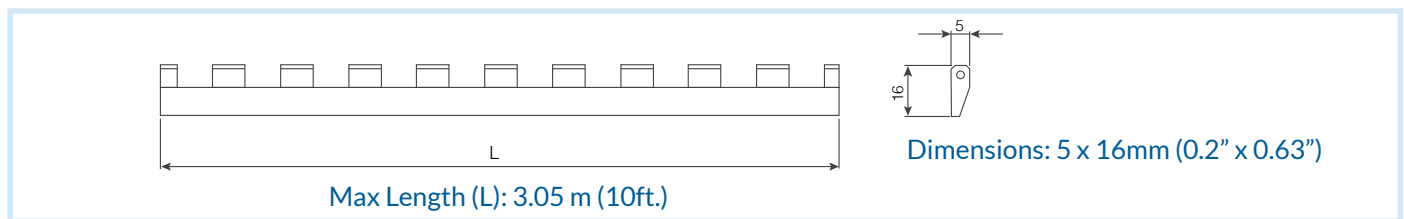

Closing belt with Universal Lace



Universal Lace

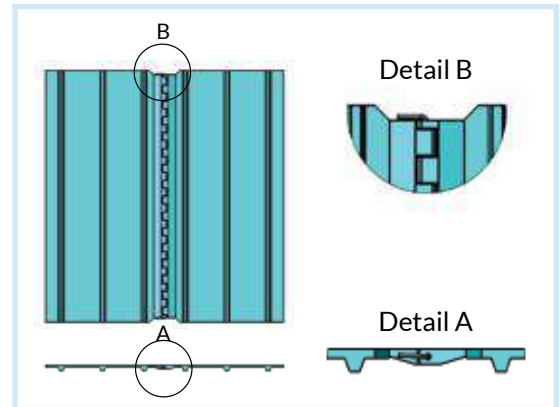

## Universal Lace Specifications

Lace & Belt Type	Volta LMW-U and LMB-U with DualDrive™		Volta LMB-U with Mini DualDrive™	
Description	Flat toothed strip		Flat toothed strip	
Material	Volta MB, Blue - MW, Beige		Volta MB, Blue	
Working Range	Suitable for belt thickness 2.5 – 5 mm			
Hardness	95A		95A	
Working Temp Range	-20°C to 60°C/ -5°F to 140°F		-20°C to 60°C/ -5°F to 140°F	
Dimensions	5 x 16 mm - 0.2" x 0.63"		5 x 16 mm - 0.2" x 0.63"	
Max Length	3.05 m - 10ft		3.05 m - 10ft	
Max Pull Force	3 kg/cm - 16.8 lb/in		3 kg/cm - 16.8 lb/in	
Minimum Pulley Normal Flex	80 mm - 3.15"		67 mm - 2.64"	
Minimum Pulley Back Flex	100 mm - 3.94"		80 mm - 3.15"	
Pin Options	Stainless Steel Pin coated with Nylon - 1.65mm/0.065" diameter	Cat. No.: 81651170	Stainless Steel Pin coated with Nylon - 1.65mm/0.065" diameter	Cat. No.: 81651170
	* Nylon (Plastic) Pin - 1.65mm/0.065" diameter with Stainless Steel leader	Cat No.: 81651130	* Nylon (Plastic) Pin - 1.65mm/0.065" diameter with Stainless Steel leader	Cat No.: 81651130
Certifications	FDA / USDA / EU			

**Note:** \* Maximum Pull force with the Nylon (plastic) Pin is 2 kg/cm (11.2 lb/in).

## Roundflex™ Lace

The Roundflex™ Lace is made of Volta homogeneous food approved materials and is compatible with Volta DR or M family product belts.

Lace Type	LMB-R, LMW-R, LDR-R, LMD-R	
Material:	Volta (MB) Blue, Blue 02, (MW) Beige, (DR & LT material) Blue 15, (MD material) Blue 09	
Working Range:	Suitable for belt thickness 2.5 – 5 mm	
Hardness:	95A	
Description:	Flat Toothed Strip	
Temp. Range:	-20°C to 60°C / -5°F to 140°F	
Certification:	FDA / USDA / EU	
Dimensions:	5 x 26mm (0.2" x 1.02")	
One Section Length (L):	260mm (10.23")	
Max. Pull Force:	3kg/cm (16.8lb/in)	
Minimum Pulley Diameter	Choose the higher MPD between the belt and the lace	
Normal Flex:	80mm (3.15")	
Back Flex:	80mm (3.15")	
Pin Options:	Nylosteel Pin - 2.4mm	Cat.No.: 81651172
	Plastic Pin - 2.4mm	Cat.No.: 81651176

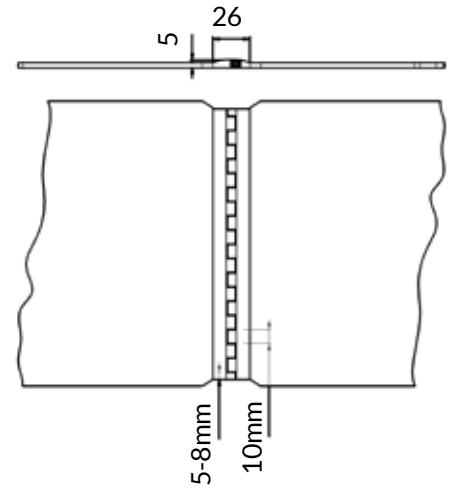

**Note:** \* Maximum Pull force with the Nylon (plastic) Pin is 2 kg/cm (11.2 lb/in).

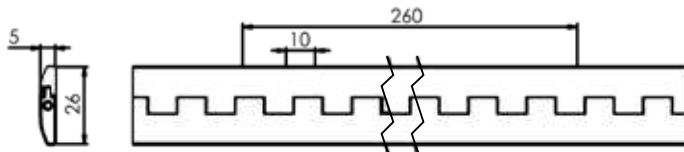

Dimensions: 5 x 26mm (0.2" x 1.23")      One Section Length (L): 260mm (10.23")



Roundflex™ Lace

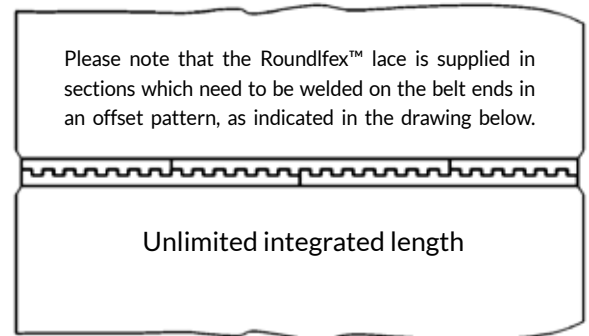

Please note that the Roundflex™ lace is supplied in sections which need to be welded on the belt ends in an offset pattern, as indicated in the drawing below.

Unlimited integrated length

## Reduced Maintenance Downtime

Volta belts are highly cleanable and do not need to be removed routinely for wash-downs even in high hygiene applications. In instances where removal is necessary, Hinge Lace reduces the risk of contamination to a minimum. The castellated lace is fabricated from homogenous belt material welded seamlessly on to the belt edges. The hinge pin may need replacing when the lace is opened.

We recommend using the Hinge Lace only when absolutely necessary. Make sure that the conveyor pulleys fully support the entire face length of the belt or at least 80% of the face length. Note that the maximum allowed pull force for the lace (per cm/ in.) is lower than the allowed pull force of the belt (per cm/ in.). Therefore, check that the calculated pull force of your belt is lower than the maximum allowed pull force of the lace.

## Mechanical Fasteners

- | There are occasions when it may be necessary to splice the DualDrive™ and Mini DualDrive™ belt using Mechanical Fasteners.
- | When working with fasteners, it is important that you work according to the manufacturer's recommendations.
- | When using fasteners for splicing the DualDrive™ and Mini DualDrive™ belt, the Pull Force calculations provided by Volta are not applicable.
- | The distance between the teeth at the splice must be the same as the distance between the teeth on the rest of the belt.
- | Volta takes no responsibility for metal fasteners or joints conforming to hygienic requirements.

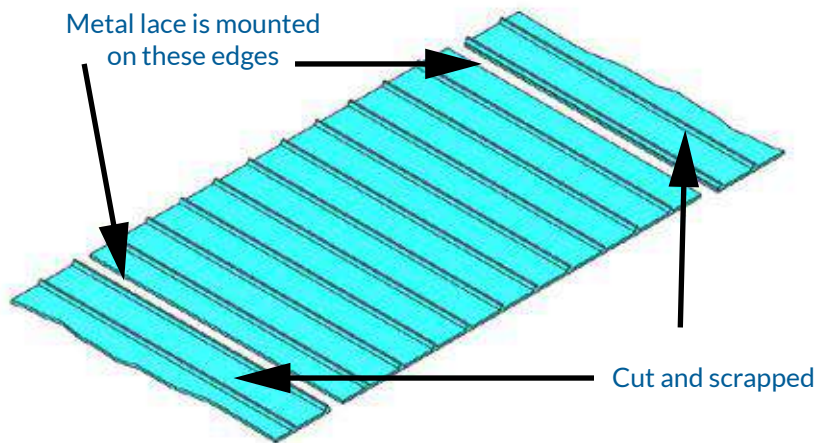

**Note:** The pitch between the driving lugs at the splice can be reduced for the DualDrive™ up to 2-3mm and for the Mini DualDrive™ up to 1mm, without adversely affecting belt operation. However, the distance between the teeth should never be increased.

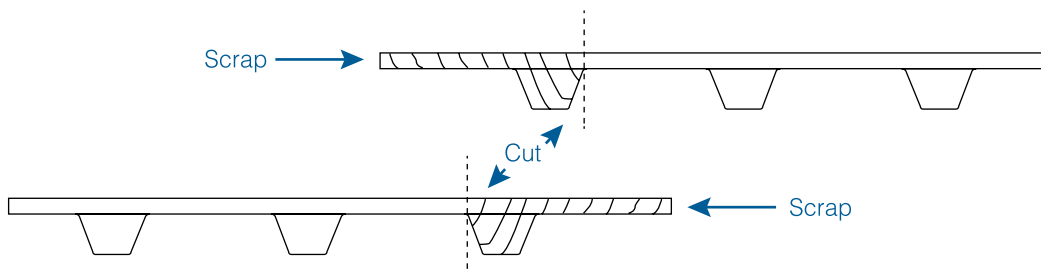

Figure 5a: Tooth pattern after joining the DualDrive™ belt with lace

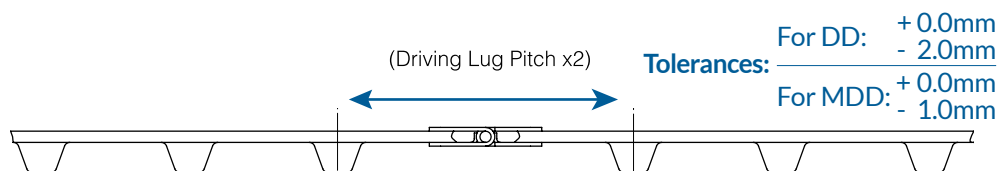

Figure 5b: Shows the correct spacing between teeth with one missing tooth

With some lace products, it may be necessary to remove one tooth completely. For these products, it will be necessary to cut each end of the belt according to the fastener's properties. After mounting the lace, the belt will have a gap of one tooth (Figure 5b). The loss of one tooth will not affect the operation of the belt. We do not recommend using this method when using sprockets of 150mm/6" or less.

For detailed splicing instructions refer to "Flat Butt Welding (FBW) Instruction Manual".

## 8. Belt Calculations

### Pull Force Calculation Procedure

1. Net Pull Force F on the belt is calculated by the formula

$$F = f_s * (G_1 + G_2) * \frac{X}{L} + f_R * G_2 * \frac{X}{L} + f_R * G_3 + C * G_1 * \frac{H}{L} + 0.25 * G_4$$

	<p>Conveyor with slide bed</p>		
Return Bed	Rollers with Bearings $f_R=0.03$	Rollers with Bushing $f_R=0.10$	UHMW Sliders $f_R$ =refer to Technical Data Sheet
Slide Bed	$f_S$ =refer to Technical Data Sheet		
<p>1. Horizontal transport</p>	C=0; L=X; H=0		
<p>2. Incline</p>	C=1		
<p>3. Decline</p>	C=-1		

### Symbols and Dimensions

**f<sub>R</sub>** = Coefficient of friction of rollers (Bearings or Bushing)  
**f<sub>S</sub>** = Coefficient of friction of belt on Slide Bed  
**L** = Conveyor length (m)/(ft)  
**H** = Elevating height (m)/(ft)  
**X** = Horizontal distance of conveyor (m)/(ft)

**G<sub>1</sub>** = Maximum load on the conveyor (kg)/(Lb)  
**G<sub>2</sub>** = Belt weight (one direction) (kg)/(Lb)  
**G<sub>3</sub>** = Weight of supporting rolls-upper and lower sections (kg)/(Lb)  
**G<sub>4</sub>** = Maximum accumulated weight (kg)/(Lb)

\* In case of Z Conveyor, the calculation is made up of two conveyors, one horizontal and one inclined. In order to find the total Pull Force, add the results of both calculations.

## 2. Pull Force Per Unit Belt Width

Divide the Calculated Pull Force from Step 1 by the belt width (cm or inch.) and record the answer.

## 3. Determine Allowed Pull Force and Pulley Diameter

The Pull Force (PF) is affected by a combination of Load and Temperature.

### Pulley Correction Factor

To determine the Allowable Pull Force (Fa) find the number of meshed teeth in the left hand column of Table 8a. If the number of meshed teeth is less than 6, multiply the Maximum Pull Force by Pulley Correction (Kp) Factor below.

Table 8a: Pulley Correction Factor (Kp)

Teeth in Mesh	Kp Factor	Comment
6 or more	1	(180° Arc of contact at standard 12T 190mm/7.47" Sprocket)
5	0.80	
4	0.60	(180° Arc of contact at standard 8T 126mm/4.94" Sprocket)

### Temperature Correction Factor

The recommended method of estimating operating temperature is to measure belt temperature at several points when fully loaded; at intake, out-feed and along the return cycle. For heavy loads at higher temperatures, the available (Pull Force) of a given belt thickness can be calculated following the correction factor below:

Table 8b: Temperature Correction Factor (Kt)

Belt material	Temperature														
	25°C/ 77°F	30°C/ 86°F	40°C/ 104°F	45°C/ 113°F	50°C/ 122°F	55°C/ 131°F	60°C/ 140°F	65°C/ 149°F	70°C/ 158°F	75°C/ 167°F	80°C/ 176°F	85°C/ 185°F	90°C/ 194°F	95°C/ 203°F	100°C/ 212°F
H - 55D Shore	1	1	1	0.95	0.87	0.85	0.80	0.75	0.67	0.64	0.61	0.57	0.53	0.47	0.44
M - 53D Shore	1	1	0.92	0.83	0.75	0.72	0.65	0.60	0.56	0.54	0.52	0.47	0.42	0.38	0.35
DR-V1 - 53D Shore	1	1	0.89	0.81	0.77	0.71	0.67	0.62	0.61	0.57	0.54	0.51	0.51	0.47	0.45
MDD-M - 95A/46D Shore	1	1	1	0.98	0.95	0.90	0.87	0.80	0.70						
LT -95A/46D Shore	1	1	1	1	1	0.85	0.70	0.55							

$$Fa = F_{max} * Kp * Kt$$

- Fa = Allowable pull force at given temperature
- Fmax = Maximum pull force allowed for the belt (use the Technical Data of each belt)
- Kp = Factor from Table 8a - Pull Force Correction Factor (Teeth in Mesh)
- Kt = Temperature correction factor

- ⚠ Certain conditions may affect the life of the belt such as temperature, cooling cycle, load, product accumulation, and certain aggressive active ingredients in the product. At higher temperatures belt life may be less than if the belt was running under normal ambient temperatures.
- In higher temperatures the color of the belts can change, especially when combined with abrasive or chemically active products.
- The belt will elongate and contract far more significantly than at room temperature. How much depends on the temperature, maximum load, belt type and friction.
- A snub roller or some form of containment for the catenary sag that results should be considered. Especially if the belt is long, care should be taken on the return to cater for the additional length to avoid it touching conveyor parts or the factory floor when elongated.
- If removed for any reason, the belt should be replaced on the conveyor when cool, to ensure the engagement with the sprocket/s and snub do not result with additional tensioning when the belt cools down.
- Recommend UHMW (PE-1000) strips to reduce friction with the slide bed.

#### 4. Verify that the Selected Belt can Carry the Calculated Pull Force

Compare the answer in step 2 to the Maximum Allowable Pull Force. If the Calculated Pull Force in Step 2, is less than or equal to Maximum Allowable Pull Force (Fa), then the selected belt is suitable for the application. You should continue with Step 5 to select the correct number of Sprockets.

If the Calculated Pull Force in Step 2 is greater than maximum Allowable Pull Force in Step 3, you must change one of the following parameters:

- Increase the belt width.
- Change the Slide Bed to reduce the coefficient of friction. Volta recommends using UHMW (PE-1000) strips.
- Add a snub roller to increase the arc of contact (to increase the number of meshed teeth).
- Choose a larger diameter Sprocket (to increase the number of meshed teeth).
- Reduce the load on the belt.

#### 5. Start - Stop Applications

Such applications require a careful additional calculation of the pull force.

Volta personnel should be consulted with full detail of the motor drive.

#### Example:

An UHMW slide bed conveyor transporting meat packages horizontally.

1. Check if FMB-3-DD 18" belt (457mm) suits for this application.

Given	English-Imperial	C
Package weight:	30 (lbs)	13.60 (kg)
Maximum number of packages on belt:	30	30
Conveyor length:	50 (ft)	15.20 (m)
Return rollers weight (bushing):	10 (lbs)	4.50 (kg)
C	6	6
Sprocket diameter:	157.70mm	6.20"
Number of teeth in mesh:	5	5

## 9. Motor Capacity Calculation

### Procedure

Calculate the Pull Force:

Maximum load:	$G1=30*30=900$ (lbs)	$G1=30*13.6=408$ (kg)
Belt weight - one direction:	$G2=0.92*(18/12)*50=69$ lbs	$G2=4.50*0.457*15.2=31.26$ kg
Return idler weight:	$G3=6*10=60$ (lbs)	$G3=6*4.50=27$ (kg)
Accumulated weight :	$G4=0$	$G4=0$

$$F = fs*(G1+G2) + fr*(G2+G3) + 0.25*G4$$

$$F = 0.28*(900+69) + 0.1*(69+60) \quad F = 0.28*(408+31.30) + 0.1*(31.30+27)$$

$$F = 284.20$$
 (lbs)  $F = 128.80$  (kg)

2. Allow Pull Force according to number of teeth in mesh:  
For 10 teeth sprockets at 180° Arc of contact - 5 teeth in mesh

$$K = 0.8$$
 (5 teeth in mesh)

3. Maximum allowed belt load:

$Fa = 0.8 * 33.6 = 26.8$ (lb/in)	$Fa = 0.8 * 6 = 4.8$ (kg/cm)
$F(\text{max}) = 26.8 * 18 = 482.4$ (lbs)	$F(\text{max}) = 4.8 * 45 = 216$ (kg)
18" belt width (45cm) is ok	
(the calculated Pull Force is less than the allowed Pull Force)	

### Calculation Procedure (for Constant Speed)

Metric	English
<b>1. Calculation of the required torque for the drive sprocket</b>	
$M = \frac{F*9.81*Dp}{1000*2}$	$M = \frac{F*Dp}{12*2}$
M= torque [N * m]	M= torque [lb*ft]
F= calculated Pull Force [kg] - see section 8, pg. 32	F= calculated Pull Force [lb] - see section 8, pg. 32
Dp= sprocket pitch diameter [mm] - see pages 15 and 18	Dp= sprocket pitch diameter [inch] - see pages 15 and 18
<b>2. Calculation of drive sprocket revolution [rpm]</b>	
$n = \frac{V*1000}{\pi*Dp}$	$n = \frac{V*12}{\pi*Dp}$
n= number of drive sprocket revolution [rpm]	n= number of drive sprocket revolution [rpm]
Dp= sprocket pitch diameter [mm] - see pages 15 and 18	Dp= sprocket pitch diameter [inch] - see pages 15 and 18
V= belt speed [m/min]	V= belt speed [ft/min]
<b>3. Calculation of the motor capacity</b>	
$P = \frac{M*n}{9550*\eta} *k$	$P = \frac{M*n}{5250*\eta} *k$
P= power in [Kw] (0.746 Kw = 1 HP)	P= power in [HP] (1 HP = 0.746 Kw)
M= torque [N * m] (from step 1)	M= torque [N * m] (from step 1)
n= number of drive sprocket revolution [rpm] (from step 2)	n= number of drive sprocket revolution [rpm] (from step 2)
$\eta$ = efficiency of the drive transmission equipment ( $\eta < 1$ )	$\eta$ = efficiency of the drive transmission equipment ( $\eta < 1$ )
It depends on the drive type and motor data provided by the manufacturer. In most cases it may vary from 0.6 to 0.85.	
k= correction/safety coefficient ( $K > 1$ )	k= correction/safety coefficient ( $K > 1$ )
Take into account working conditions according to the motor and drive gear data provided by the manufacturer.	
<b>4. Choose a motor: the next size up</b>	

# DualDrive™ & Mini DualDrive™ Belts

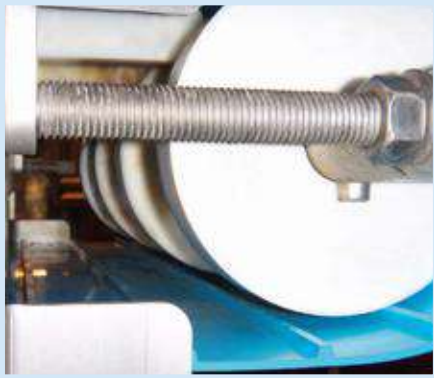

Smooth Tail Roller

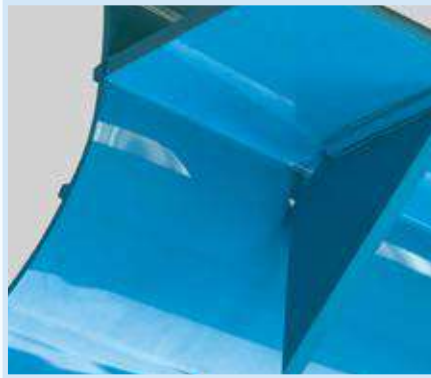

Gusset Cleat on DD



Return Side Support



Perforated Mini DD Belt



Volta Drive Sprocket



Volta Drive Sprockets



DD Meat Elevator



Perforated FMB-DD-IRT Belt



Perforated DD Belt with Flights



[www.voltabelting.com](http://www.voltabelting.com)

CORPORATE  
HEADQUARTERS  
Sales and Manufacturing  
[sales@voltabelting.com](mailto:sales@voltabelting.com)

USA  
Tel. +1 830 229 2384  
[voltaus@voltabelting.com](mailto:voltaus@voltabelting.com)

EUROPE  
Tel. +31 546 580166  
[voltaeu@voltabelting.com](mailto:voltaeu@voltabelting.com)

ASIA  
Tel. +84 251 352 1967  
[voltaasia@voltabelting.com](mailto:voltaasia@voltabelting.com)



Volta Belting makes no warranty with respect to any of its products for a particular purpose. See Volta General Terms and Conditions.  
Copyright© Volta Belting Technology Ltd. | CAT210EN00 - Ver.H.August.2024.